

# SHOR-LINE<sup>®</sup>

# PRODUCT CATALOG



# 2017-18

# SHOR-LINE INNOVATION

Shor-Line takes pride in listening and responding to customer needs. Our innovation team has been busy working on new housing and surgery products that improve the lives of pets and the people who work with them.

Two trends that have driven innovation this year are low stress and feline products. We are introducing the Short V-Top Surgery Tables, ideal for feline surgery. We also are continuing to add accessories for new and retrofitted Stainless Steel cages.

- **Classic Short V-Top Surgery Table** Our beloved Classic V-Top Surgery table just got a new family member with the Short V-Top. It is 46" L but has the same great features as our full-length model.
- **Continuum Short V-Top Surgery Table** Fans of the Continuum V-Top Surgery table now can have a shorter V-Top. Like its Classic cousin, it has the same great features in the Short V-Top as the longer model.
- **Cat Lounging Bench** Felines love to crouch down, and the Cat Lounging Bench gives them a safe place to snuggle down. The gray polyethylene bench warms up with the cat's body heat. Place it in a kennel or in an open space.
- **Kat Portal** Studies show felines in boarding or shelter situations do better with more space. The polyethylene portal installs easily with a nibbler-type saw to make the holes for connecting two Stainless Steel cages.

## COMING SOON!!

We are excited for the new items pending release in 2017. Among the items we have in beta testing are:

- **Prelude Series LED Exam Lights** Currently testing Single Wall Mount, Single Ceiling Mount and a Mobile LED Exam Lights in 2017. Look for them in late summer or fall.
- **Fear Free Exam Table** Beta version of our Fear Free Exam Table launched at North American Veterinary Conference and Western States Veterinary Conference this year. Beta testing phase to begin soon.
- **Wet/Dry Table Extension** Veterinarians and technicians looking for a little more space or a wet table extension gave us some feedback on a beta unit at recent trade shows. We will continue the testing process in 2017.



Classic Short V-Top

Continuum Short V-Top



Prelude Series Wall Mount Exam Light



Cat Lounging Bench



Kat Portal



Wet/Dry Table Extension

# TABLE OF CONTENTS

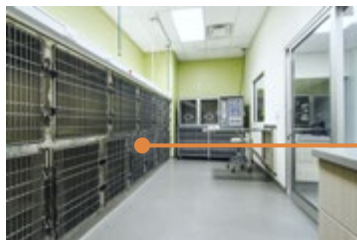

Stainless Steel Cages



Swivel Feeder

## HOUSING 4

- Kennels..... 5
- Kennel Run Accessories..... 26
- Cages ..... 27
- Cage Accessories ..... 36
- Cat Condos + Suites ..... 40
- Low Stress Housing Options..... 48
- Feeding Accessories..... 49
- Animal Handling Accessories ..... 51

## GROOMING 52

- Tables ..... 52
- Tubs ..... 54
- Grooming Accessories ..... 56
- Dryer Cages..... 58

## TABLES 59

- Exam..... 59
- Utility Chases..... 65
- Corner Guards and Kick Plates..... 65
- Exam + Treatment ..... 66
- Tub Tables ..... 67
- Surgery ..... 71
- Utility ..... 75
- Table Accessories ..... 77



Short V-Top  
NEW! 46" L V-Top

## LIGHTING 79

- LED..... 80
- Halogen..... 81



Prelude Series LED Exam Lights

## ANESTHESIA 82

- Anesthesia Machines..... 83
- Oxygen Concentrators ..... 86
- Accessories..... 88

## SCALES 89

- Blue-Line..... 91
- K9-W8..... 92

## CRITICAL CARE 93

- Warming Pads ..... 93
- Oxygen Therapy..... 94
- IV Products ..... 97

## SPECIALTY + DIAGNOSIS 99

- Microscopes ..... 99
- Centrifuges..... 100
- Autoclaves ..... 101
- Accessories..... 102
- Diagnostic Equipment..... 103

## TERMS + CONDITIONS 104

## CONTACT US 107



O2 Cage Door can retrofit most Shor-Line Cages.

# HOUSING

## SHOR-LINE CELEBRATES ITS 90<sup>TH</sup> YEAR IN 2017!!!

We have been manufacturing high-quality animal housing for three generations. But this is not just a family company. No matter what job a Shor-Line employee does, the common denominator is a love for animals... and the safety of their handlers. Everyone wants to make a product they would want used with their pet.

You can see the craftsmanship in every product we make. Our kennels and cages have housed cherished pets for almost 60 years, so we have learned how important high-quality housing is to an animal's well being.

As you choose your housing, ask us lots of questions. Our goal is to satisfy your needs because we know your investment will last for decades. You will be satisfied with your purchase, we guarantee it.

Your partner in excellence,

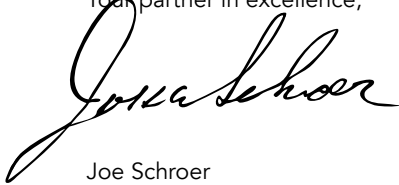

Joe Schroer  
President



Upgrading or installing new animal housing is a big job, and we are here to help. When you are in the planning stages, we offer several **FREE** tools:

- **Cage Gallery**  
View on [shor-line.com](http://shor-line.com)
- **Kennel Run Gallery**  
View on [shor-line.com](http://shor-line.com)
- **Cat Condo Gallery**  
View on [shor-line.com](http://shor-line.com)
- **T-Kennel Design Guide**  
Request via phone or downloadable on website
- **Kennel Run System Checklist**  
Request via phone or downloadable on website

You can also always call our helpful sales representatives. They have decades of experience installing animal housing in your area, and chances are they can solve your most difficult challenges.

One of the key questions they will ask pertains to how you want/need to handle your flooring and drainage.

- Concrete floor with trench drain
- Concrete floor with hole drain
- Concrete floor without drain
- Raised floor with trench drain

Get your ideas together and call our team to get started!





# KENNELS/RUNS

Kennel runs are ideal choices for many reasons. They can be grand home-like areas or more basic housing. The run height (72" or 78") gives good air circulation and a spacious feel.

Shor-Line sales representatives can work with you or your architect in mixing and matching different run styles to fit all your needs. Whether it is a luxury boarding area or a surgery recovery zone, there is a run design that meets your needs.



Dutch Door gives a home-like feel to the kennel area. You can build this into a home-like setting or have it stand alone. Use your imagination to create a "neighborhood." See page 25.



Accessories make it better for the dogs and easier for their caretakers. Consider some built-in options, such as the new Shor-Line Swivel Feeder. See page 26.

Double Decker Kennels are great for small dogs. See page 20.



# ANATOMY OF A: SHOR-LINE RUN SYSTEM

Shor-Line Stainless Steel Kennels are the crown jewel of our Shor-Line family. Years of craftsmanship have gone into creating our industry leading kennels that will last decades in your facility.

These runs are entirely constructed of stainless steel components, including a 1¼" stainless steel tube frame and stainless steel door. Two heavy-gauge stainless steel panels are sandwiched between a Sound Dampening Technology core to help reduce sound and add strength.

The shine of stainless will reflect the quality of your organization, so we are committed to making it available in many sizes and designs to meet the unique needs of your facility.

## Glass Colors



## Performance Features:

- 6'6" run height.
- 1¼" Stainless Steel tubing with mitered corners.
- ¼" Stainless Steel wire panel spaced every 6" for security.
- Wire panel rods welded at every intersection.
- Choose from Tempered Glass or Wire Doors.
- Tempered Glass available on doors, side panels and/or back panels.
- Rods pass into gate frame tube for added security.
- 16-gauge Stainless Steel hardware.
- Dual Pin Latch for security (can be locked).
- Hands-free latch operation.
- Side panels available in 48" isolation or full isolation.
- Nylon, brass or flag hinges are available.
- Wedge Kennel Run System follows the slope of the floor to prevent cross contamination.
- Inside run width is specified gate size.
- Gates mount between side panels or walls.
- Optional feeding systems for food and water available, but must be ordered when doors are made because it can't be retrofitted.

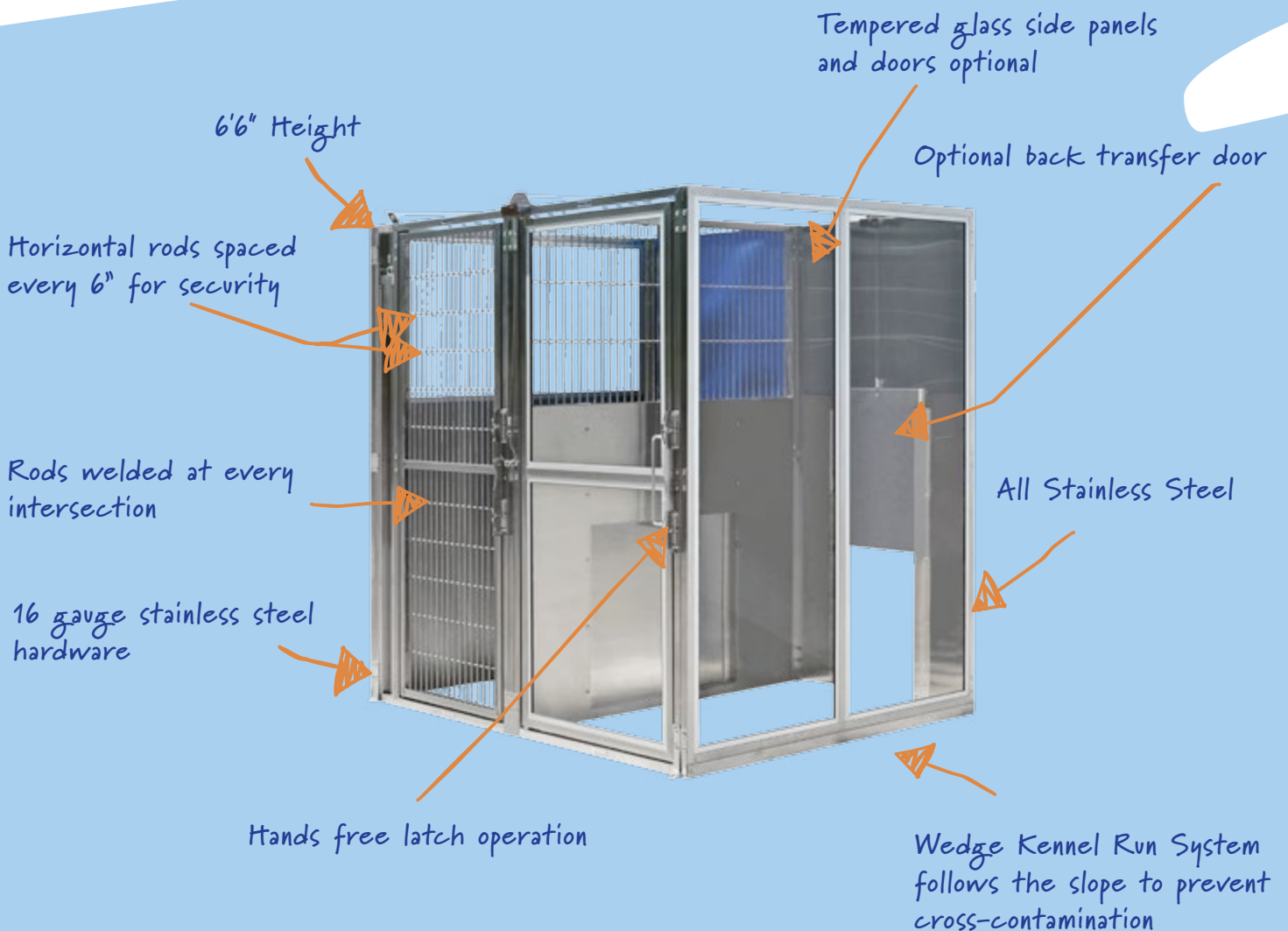

# ANATOMY OF A: T-KENNEL RUN SYSTEM

T-Kennel offers Run Systems that work indoors or outdoors. If you can dream it, we can build it! These pages introduce you to our high-quality products and different ways you can combine them to build or renovate your facility.

## Performance Features:

- 6' run height.
- 1" Stainless Steel tubing with mitered corners.
- 3/16" Stainless Steel wire panel spaced every 6" for security.
- Wire panel rods welded at every intersection.
- Choose from Tempered Glass or Wire Doors.
- Tempered Glass available on doors, side panels and/or back panels.
- Rods pass into gate frame tube for added security.
- 16-gauge Stainless Steel hardware.
- Single Pin Latch for security (can be locked).
- Hands-free latch operation.
- Side panels available in 48" isolation or full isolation.
- Adjustable drop bar follows the slope of the floor to prevent cross contamination.
- Gate can open in or out and is completely removable.
- Two strong (0.093) PVC panels are sandwiched between a Sound Dampening Technology core to help reduce sound and add strength.
- Optional feeding systems for food and water available, but must be ordered when doors are made because it can't be retrofitted.
- Outdoor applications are available.

## Standard PVC Colors

8321	3530	2357
7327	8343	7387

## Premium PVC Colors

5137	4288	8444
4300	6132	7300
8426	2354	1562

Premium PVC Panel colors and custom colors must be special ordered and require a buying minimum

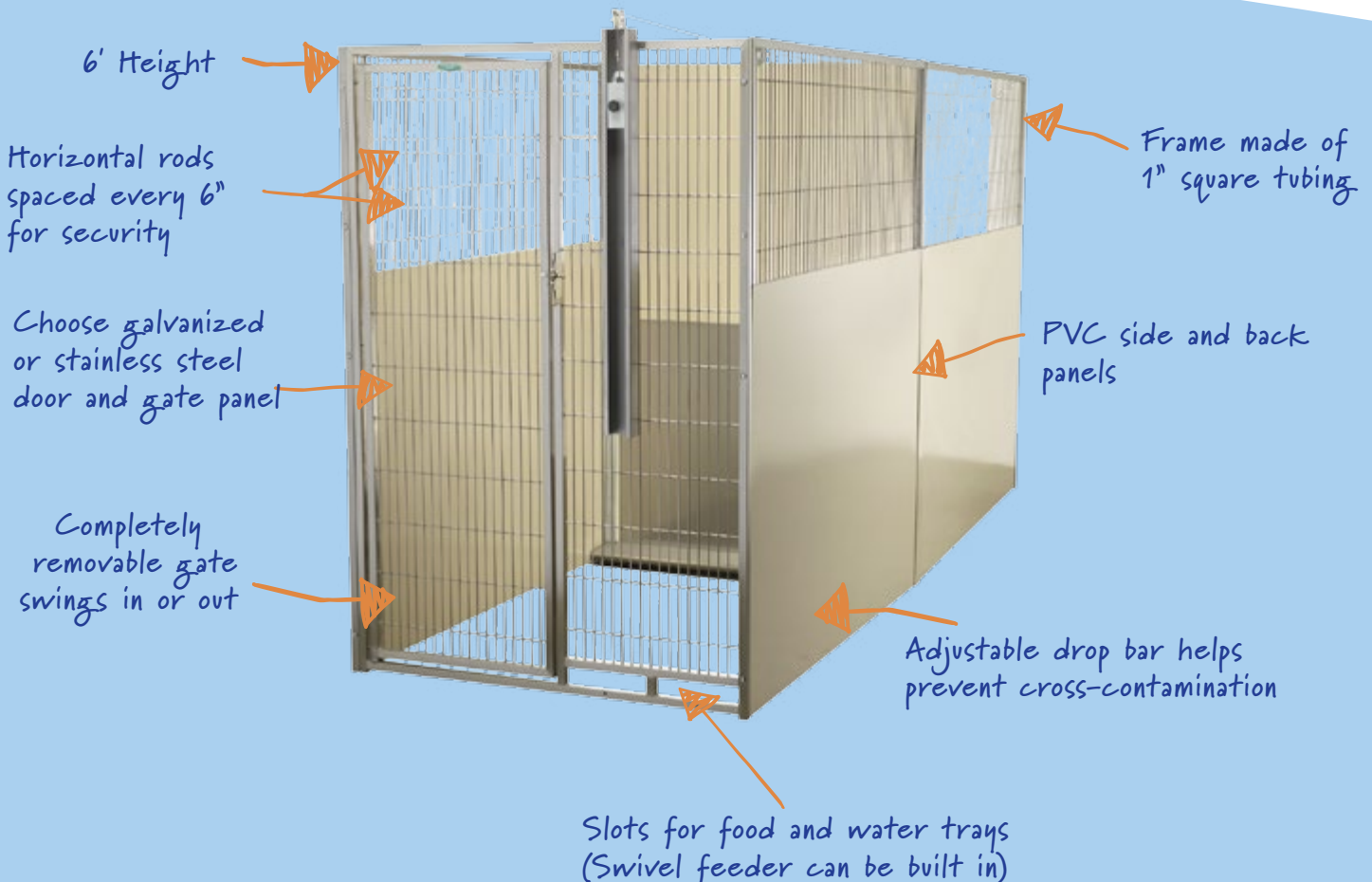

# HOW TO BUY SHOR-LINE KENNELS

## FLOOR



1



2







3



3

**Overall benefits:** Size of the gate and side panels will determine the animal space.

- 1  **Concrete Floor with Trench Drain Cover**  
Your facility is built with a trench drain system and the kennel walls sit on concrete. We offer half and full trench drain covers (half is shown). An alternative is to cover the Trench Drains with a Flip Up Resting Bench. See page 23.
- 2  **Sloped Floor with Concrete Trench Drain**  
The built-in side panel and wedge system has an adjustable wedge that conforms to the concrete slope. Once sealed, it creates a barrier against cross contamination. It works with your existing trench drain system.
- 3  **Elevated PVC-Coated Floor**  
We take a 14-gauge, round-holed, heavy-duty steel sheet and coat it with about 1/8"-thick layer of PVC coating.
- 4  **Also available with hole drain or no drain.**

## GATE + BACK PANEL SIZE

 30" Wide

 36" Wide

 48" Wide

## SIDE PANEL SIZE

 5' Long



 6' Long



## GATE STYLE



**Overall benefits:** All gate frames are constructed of welded 1¼" square tubing and wire mesh (when applicable). All gates are stainless steel and are 6'6" high.





- 1  **Full Stainless Steel Frame**  
Gate frame and gate panel are constructed of welded 1¼" square stainless steel tubing and stainless steel wire mesh.
- 2  **Stainless Steel Frame + Glass Door Gate**  
Gate frame and door are constructed of welded 1¼" square stainless steel tubing. Tempered glass is encased by an aluminum extrusion mounted to the gate and door frame.
- 3  **Stainless Steel without Bottom Bar**  
Door is constructed of welded 1¼" square stainless steel tubing with reinforced frame and stainless steel wire mesh.

**Note:** Any Shor-Line door can have a Swivel feeder added. See page 26.

## SIDE PANEL TYPE





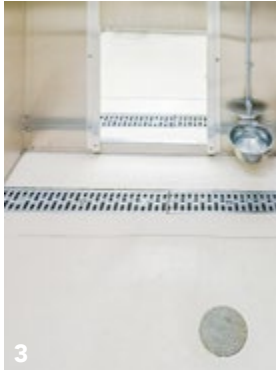

**Overall benefits:** Standard side panels are sloped ¼" per foot. Other slopes available on request.

- 1  **Full Isolation**  
Strong stainless steel panels add brightness and make cleaning easy. Two heavy-gauge stainless steel panels are sandwiched between a Sound Dampening Technology core to help reduce sound and add strength. Also available in tempered glass or PVC. Full isolation covers the entire 6'6".
- 2  **48" Isolation**  
Choose from heavy-duty stainless wire mesh or tempered glass for the 30" top section and your choice of stainless steel, or PVC for the bottom 48" section. Uses the same Sound Deadening Technology as Full Isolation.
- 3  **Side Panel with Transfer Door**  
Guillotine transfer door can operate on one side and allow pet to travel between kennels. Door is ⅛" thick aluminum, H channel is ⅜" aluminum and cable is ⅜" aircraft-grade stainless steel cable.
  - 16"W x 24"H opening with 18"W x 28"H door
  - 16"W x 32"H opening with 18"W x 35"H door
  - 24"W x 32"H opening with 26"W x 35"H door
- 4  **Full Height or 48" Cement Masonry Unit**  
Benefits are no cross contamination possibilities and total isolation. Disadvantage is that it is a permanent structure and the block width reduces kennel size. (Shor-Line does not install nor sell concrete block). You can place our 30" stainless steel or tempered glass Flag Panels on top.

## BACK PANEL TYPE



**Overall benefits:** Standard back panels are sloped  $\frac{1}{4}$ " per foot. Other slopes available on request.

- 1  **Full Isolation**  
Stainless steel panels add brightness and make cleaning easy. Full isolation covers 6'6".
- 2  **48" Isolation**  
Heavy duty stainless steel mesh covers the 30" top section. Choose stainless steel or PVC panels for the bottom 48".
- 3  **Back Panel with Transfer Door**  
Guillotine transfer door can operate on two sides and allow pet to travel between kennels. Door is  $\frac{1}{8}$ " thick aluminum, H channel is  $\frac{3}{16}$ " aluminum and cable is  $\frac{3}{32}$ " aircraft-grade Stainless Steel cable.
  - 16"W x 24"H opening with 18"W x 28"H door
  - 16"W x 32"H opening with 18"W x 35"H door
  - 24"W x 32"H opening with 26"W x 35"H door
  - Special Transfer Door sizes upon request
- 4  **No Back Panel**  
In many spaces, you can use your existing wall as the kennel back panel. (This includes CMU walls.)

## SHOR-LINE Single Kennel

### Benefits:

The quality of this kennel is evident in the extra premium features, such as welds at every intersection and the smooth feel of crafted stainless steel. A pet in a Shor-Line kennel is protected by our well-crafted kennel that will withstand decades of use.

You choose the width and length to fit your needs, and mix and match side and back panels to make a statement. If you can dream it, we will make your vision sparkle!

### Features:

- Our most durable kennel system features full stainless steel available throughout this kennel.
- Frame is made up of 1¼" square tubing.
- Stainless steel is the best and easiest surface to clean and disinfect.
- Installed freestanding or against a wall using modular components.
- Stainless steel side panels are sloped ¼" per foot. Other slopes available by request.
- Optional PVC Isolation side panels are available in multiple colors to complement your decor.
- Two heavy-gauge stainless steel panels are sandwiched between a Sound Dampening Technology core to help reduce sound and add strength.
- **Optional accessories:** Top wire panel, side transfer door, stainless steel glass door, elevated PVC floor and swivel feeding system.
- **Specs:** standard widths: 30", 36" and 48"; standard depths: 5' and 6'; height 6'6" (approx.) 7' 2" (approx.) on elevated PVC Floor.

See "How to Buy Shor-Line Run Systems" on page 8 for outline of options.



## SHOR-LINE Side-to-Side Kennel

### Benefits:

The Side-to-Side connects two single kennels. It gives more space for dog families or can protect your staff because the operator can make the transfer without animal contact.

The side transfer door works with a pulley system, enabling the operator to open the transfer door to move the animal from one side to the other. Rotating dogs has never been easier! Can be free-standing or mounted to an existing structural wall. Works well against a wall.

### Features:

- Our most durable kennel, this kennel's stainless beauty will last for years.
- Frame is made up of 1 1/4" square tubing.
- May be installed freestanding or against a wall.
- Stainless steel side panels are sloped 1/4" per foot. Other slopes available by request.
- Stainless steel is the best and easiest surface to clean and disinfect.
- Tempered glass or multiple colors of PVC panels are available to complement your decor.
- Two heavy-gauge stainless steel panels are sandwiched between a Sound Dampening Technology core to help reduce sound and add strength.
- **Optional accessories:** Top wire panel, side or back transfer door, stainless steel glass door, elevated PVC floor, swivel feeding system.
- **Specs:** standard widths: 30", 36" and 48"; standard depths: 5' and 6'; height 6'6" (approx.) on concrete. 7' 2" (approx.) on elevated PVC Floor

See "How to Buy Shor-Line Run Systems" on page 8 for outline of options.





## SHOR-LINE Front-to-Back Kennel

### Benefits:

The Shor-Line Front-to-Back Kennel System places two Single Kennels back to back. Comes with a counter-weighted transfer door to link them. The enclosed double pulley system enables the operator to open the transfer door from either side allowing the animal to transfer from one side to the other. The operator does not have to handle the animal.

### Features:

- Each kennel has two openings.
- An enclosed double pulley system operates a counter-weighted transfer door that may be opened from either end for ease of transferring animals.
- Works best in larger rooms that can accommodate aisles down each side of the room.
- Transfer door included.
- Patented Dual Pin Latch System for security.
- Two heavy-gauge stainless steel panels are sandwiched between a Sound Dampening Technology core to help reduce sound and add strength.
- **Optional accessories:** Top wire panel, side transfer door, stainless steel glass door, elevated PVC floor, swivel feeding system.
- **Specs:** standard widths: 30", 36" and 48"; standard depths: 10' and 12'; height 6'6" (approx.) on concrete. 7' 2" (approx.) on elevated PVC Floor

See "How to Buy Shor-Line Run Systems" on page 8 for outline of options.



# HOW TO BUY T-KENNEL RUN SYSTEMS

## FLOOR



**Overall benefits:** Size of the gate and side panels will determine the floor dimensions.

- 1  On Concrete with Trench Drain Cover  
Economical alternative to Stainless Steel but it may require maintenance over time.
  - 2  Raised Floor  
The raised floor allows you to disassemble and move the runs, if needed. It also allows you to connect to a drain or not (trench drain covers optional).  
The flooring is 0.187 PVC in a variety of colors.
- Also available with hole drain or no drain.

## FRAME STYLE



- 1  Stainless Steel  
Best looking frame. Holds up well to liquids and cleaning products and is virtually maintenance free.
  - 2  Galvanized  
Durable frame at lower price. Galvanized steel does require some maintenance because the metal dulls over time. Not as forgiving of cleaning solutions.
- Stainless Steel + Galvanized  
A money-saving option is to go with a stainless steel gate that will withstand wear better and then use a galvanized frame for the remaining sides. If you are covering the sides with PVC, the difference will barely be noticeable.

**Note:** Any T-Kennel door can have a swivel feeder added. (See page 26.)

## GATE + BACK PANEL SIZE

- 3' Wide
- 3' 6" Wide
- 4' Wide

## SIDE PANEL SIZE

- 4' Long
- 5' Long
- 6' Long
- 8' Long

## GATE STYLE



1



2



3

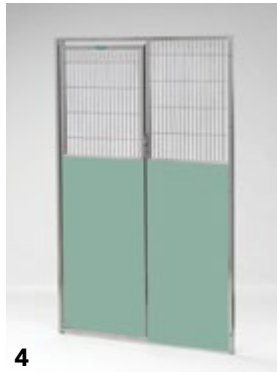

4

**Overall benefits:** All 6' H gate frames and panels are constructed of welded 1" square tubing and wire mesh (when applicable). All gate frames can come with or without feeding slots.

- 1  **Stainless Steel**  
Solid stainless steel frame provides maximum durability and clean look.
- 2  **Galvanized**  
Not as durable as stainless steel but is more economical, All our galvanized gates and frames are hot dipped after fabrication to increase durability, strength and longevity.
- 3  **Tempered Glass**  
The frame is stainless steel. Tempered glass is encased in an aluminum extrusion, and we mount that to the gate frame.
- 4  **Half PVC**  
The frame is stainless steel or galvanized, and the top 24" wire mesh matches it (Tempered glass is an option). The lower 48" can be PVC of various colors.

## SIDE PANEL TYPE



1



2







3



4



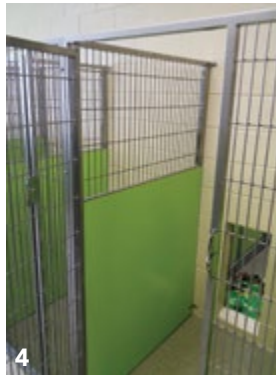
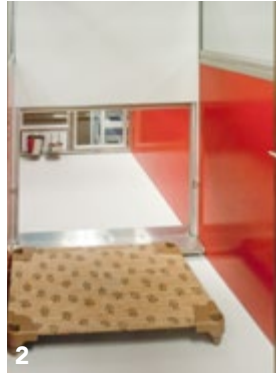

**Overall benefits:** Standard side panels are sloped 1/4" per foot. Other slopes available on request.

- 1  **Full Isolation**  
Two strong (0.093) PVC panels are sandwiched between a Sound Dampening Technology core to help reduce sound and add strength. The panels add color and make cleaning easy. Full isolation 6'.
- 2  **48" Isolation**  
Choose between stainless steel, hot-dipped galvanized mesh or tempered glass for 24" top section. Strong (0.093) PVC panels (bottom 48") clean easily and add color. Uses the same Sound Dampening Technology as Full Isolation.
- 3  **Side Panel with Transfer Door**  
Guillotine transfer door operates from one side only, and allows pet to travel between to kennels. Two transfer door styles are available.
  - 18"W x 24"H opening held with caribiner
  - 18"W x 24"H opening counter weighted
  - Special Transfer Door sizes upon request
- 4  **Full Height or 48" Cement Masonry Unit**  
Benefits are no cross contamination possibilities and total isolation. Disadvantage is that it is a permanent structure and the block width reduces kennel size. (Shor-Line does not install nor sell concrete block.) You can place our 24" stainless steel or galvanized wire mesh, tempered glass or PVC panels on top.

## BACK PANEL TYPE



**Overall benefits:** Options allow for full back panels to transfer doors to CMU.

- 1  **Full Isolation**  
Strong (0.093) PVC panels add color and make cleaning easy. Full isolation covers the entire 6' height.
- 2  **Back Panel with Transfer Door**  
Guillotine transfer door operates from two sides and allows pet to travel between kennels. The opening runs the full width, so size depends on kennel width.
  - Full width opening counter weighted, (3', 3'6", 4')
- 3  **Cement Masonry Unit with Transfer Door**  
We can install an exterior-mounted transfer door to a CMU system. We have doors available in most sizes. Door is 1/8" thick aluminum, H channel is 3/16" aluminum and cable is 3/32" aircraft-grade stainless steel cable.
- 4  **No Back Panel**  
In many spaces, you can use your existing wall as the kennel back panel. (This includes CMU walls.)

## PVC PANEL COLORS

### Standard Colors

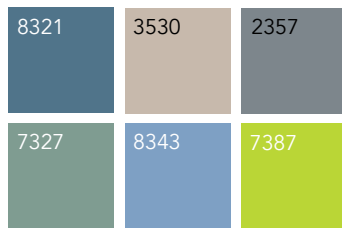

### Premium Colors

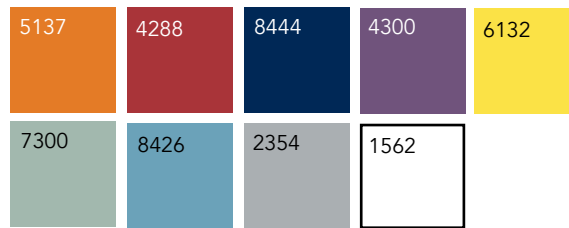

-  Standard
-  Premium

### Low Stress Color Palette

Encourages lighter shades, try in standard 7327, 3530, 8343 or 2357. For Premium try 7300 or 2354.

\* Premium PVC panel colors and custom colors must be special ordered and require a buying minimum.

## GLASS PANEL COLORS

### Glass Colors

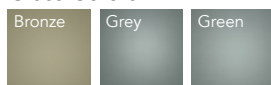



## T-KENNEL Single Kennel

### Benefits:

This functional but fun T-Kennel Run System allows you to design a room that makes good use of space. Our options for colored PVC, tempered glass, stainless and galvanized steel let you mix and match your look to fit budget and aesthetic choices.

### Features:

- Durable frame is made up of 1" square tubing.
- You can install freestanding or against a wall.
- Includes one 2' wide gate that opens inward and outward.
- Has two slots for optional slide-in feed and water trays. (Any Kennel Run System less than 4' wide will receive only one feed tray slot.)
- Raised floor systems can run 32' in either direction before a stub out is needed and features leveling legs to rectify floor imperfections.
- Standard side panels are sloped  $\frac{1}{4}$ " per foot from front to rear. Other slopes available by request.
- Raised Floor Systems include a back panel.
- Two strong (0.093) PVC panels are sandwiched between a Sound Dampening Technology core to help reduce sound and add strength.
- Easy to clean PVC Panels are available in multiple colors to complement your decor.
- **Optional accessories:** top wire panel, side transfer door, stainless steel wire door and stainless steel glass door. Choice of Stainless or galvanized steel components.
- **Specs:** standard Widths: 3', 3'6", & 4'; standard lengths: 3', 4', 5', 6' & 8'; standard height: 6' on concrete (approx.), 6' 10" on raised floor (approx.).

See "How to Buy T-Kennel Run Systems" on page 14 for outline of options.

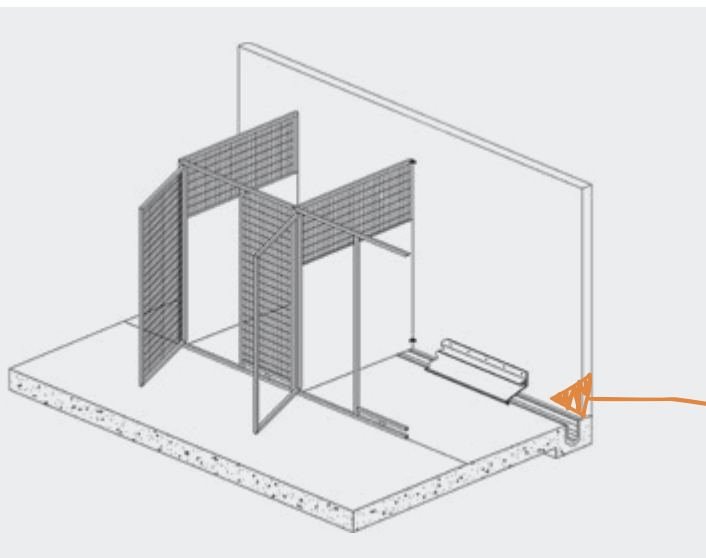

Trench drain with half T-Cover.

## T-KENNEL Side-to-Side Kennel

### Benefits:

This is ideal for housing family groups or people-aggressive dogs. You can fit the Side-to-Side Kennel Run System with a side transfer door. The pulley system enables the operator to make a hands-free transfer by opening the transfer door to move the animal to the other side. Can be freestanding or mounted on an existing structural wall.

### Features:

- Durable frame is made up of 1" square tubing.
- Has two slots per compartment for optional slide-in feed and water trays. (Any Kennel Run System less than 4' wide will receive only one feed tray slot.)
- Raised floor systems feature leveling legs and can run 32' in either direction to rectify floor imperfections before a stub out is needed.
- Standard side panels are sloped  $\frac{1}{4}$ " per foot. Other slopes available by request.
- Two strong (0.093) PVC panels are sandwiched between a Sound Dampening Technology core to help reduce sound and add strength.
- Easy to clean PVC Panels are available in multiple colors to complement your decor.
- **Optional accessories:** top wire panel, side transfer door, stainless steel wire door and stainless steel glass door. Choice of Stainless or galvanized steel components.
- **Specs:** standard widths: 3', 3'6", & 4'; standard depths: 4', 5', 6' & 8'; standard height: 6' on concrete (approx.), 6' 10" on raised floor (approx.).

See "How to Buy T-Kennel Run Systems" on page 14 for outline of options.



Side transfer door

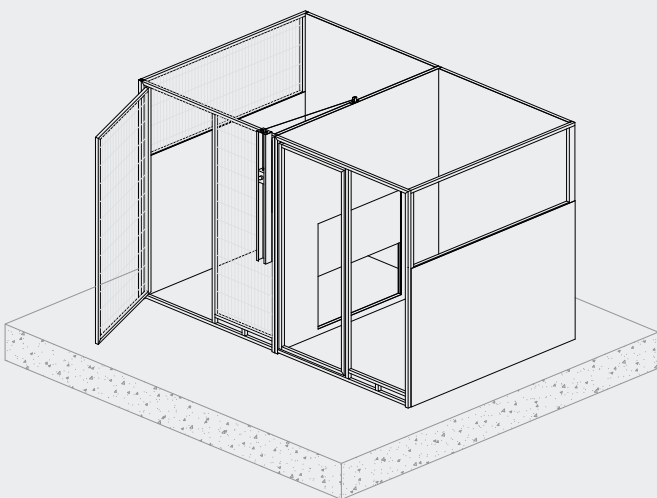

## T-KENNEL Front-to-Back Kennel

### Benefits:

The Front-to-Back Kennel Run System places two single kennels back to back, separated by a full width, counter-weighted, transfer door. The enclosed double pulley system enables the operator to open the transfer door from either side. This allows the animal to transfer to the other side without operator contact. This is a time saver as well as a safety feature.

Facility managers have reported quieter and calmer dogs because the animals are not facing each other.

This System can sit directly on the finished floor or have a raised floor system with an integrated trench drain system covered by the full T-Cover.

### Features:

- Each kennel has two compartments—a full-width transfer door is included.
- An enclosed double-pulley system operates a full-width, counter-weighted transfer door that you can open from either end to make transferring animals easy.
- Each compartment has one 2' wide gate that opens in or out.
- Includes two slots per compartment for optional slide-in feed and water trays. (Any kennel less than 4' will receive only one feed tray slot.)
- Raised floor systems feature leveling legs and can run 32' in either direction to rectify floor imperfections before a stub out is needed.
- Full T-Cover, with baffle, bridges the trench at the midsection to prevent cross-contamination when cleaning.
- Two strong (0.093) PVC panels are sandwiched between a Sound Dampening Technology core to help reduce sound and add strength.
- Easy to clean PVC Panels are available in multiple colors to complement your decor.
- **Optional accessories:** top wire panel, side transfer door, stainless steel wire door and stainless steel glass door. Choice of Stainless or galvanized steel components.
- **Specs:** standard widths: 3', 3'6", & 4'; standard depths: 8', 10', 12' & 16'; standard height: 6' on concrete (approx.), 6' 10" on raised floor (approx.).

See "How to Buy T-Kennel Run Systems" on page 14 for outline of options.



Full T-Cover

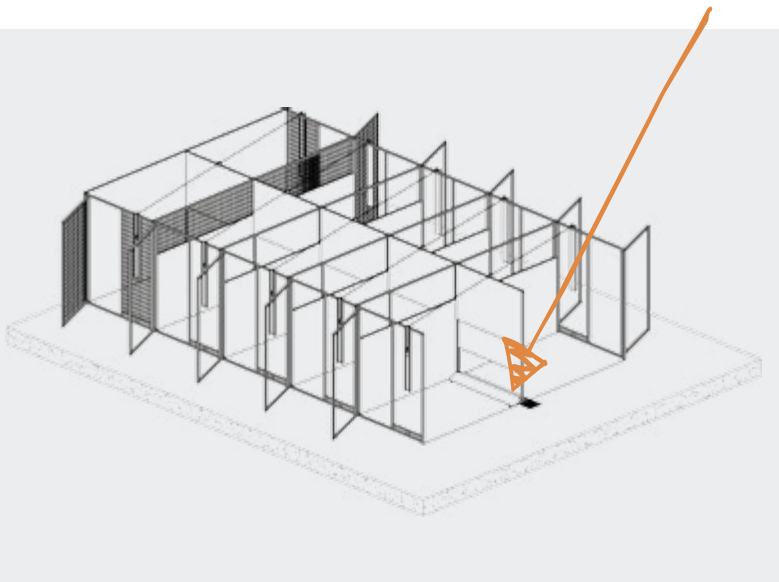



## T-KENNEL Double Decker Kennel

### Benefits:

The Double Decker Kennel Run System saves valuable floor space by stacking two kennels on top of each other. The top unit floor is 35" off the floor (if unit is ground level), so you are at about counter height. Use color on the PVC panels or select tempered glass to create a statement. Flexibility can be beautiful!

### Features:

- Frame is made up of 1" tubing, and wire is welded to the frame. Wire mesh top piece included.
- One door per compartment is included. All gates open inward and outward.
- Great for placement against a wall or freestanding.
- Has two slots for optional slide-in feed and water trays. (Any Kennel Run System less than 4' wide will receive only one feed tray slot.)
- Raised floor systems feature leveling legs and can run 32' in either direction to rectify floor imperfections before a stub out is needed.
- Standard side panels are sloped  $\frac{1}{4}$ " per foot. Other slopes available by request.
- Two strong (0.093) PVC panels are sandwiched between a Sound Dampening Technology core to help reduce sound and add strength.
- Easy to clean PVC Panels are available in multiple colors to complement your decor.
- **Optional accessories:** Side transfer door and stainless steel or tempered glass door.
- **Specs:** standard widths: 3' and 4'; standard depths: 3' and 4'; each opening is 34" high, overall height: 6' on concrete (approx.), 6' 10" on raised floor (approx.).

See "How to Buy T-Kennel Run Systems" on page 14 for outline of options and "Door Styles for T-Kennel Double Decker, Tri and Quad Kennels" on page 23.



Marry Stainless Steel  
and glass panels for good ventilation!



Half T-Covers plus drain system that connects top trench drain below.

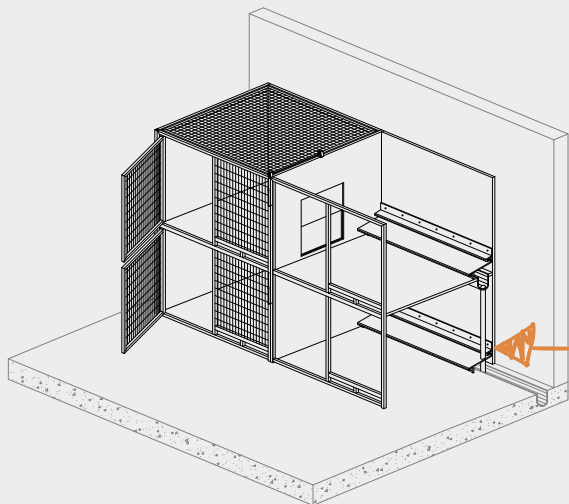



## T-KENNEL Tri Kennel

### Benefits:

This unit pairs our Double Decker Kennel with a Single Kennel to create a flexible housing unit. The full-width, counter-weighted, transfer door allows the pet to travel from one lower unit to the other.

This works best in large rooms where there is space enough to get to both sides of the Kennel Run System. It can be a good choice for housing dog families.

### Features:

- Frame is made up of 1" tubing, and wire is welded to the frame. Wire mesh top piece included for the Double Decker side, optional on other side.
- The Tri Kennel contains three separate compartments, so it's great for boarding dogs of all sizes.
- A full width, counter-weighted transfer door between the bottom two compartments is operated by an enclosed double pulley system. You can open the transfer door from either side for easy animal transfer.
- Has two slots for optional slide-in feed and water trays. (Any Kennel Run System less than 4' wide will receive only one feed tray slot.)
- One gate per compartment is included. All gates open inward and outward.
- The upper floor drain is covered by a half T-Cover.
- The lower floor drains are covered by a full T-Cover that bridges the trench at the midsection to prevent cross-contamination when cleaning.
- Raised floor systems feature leveling legs and can run 32' in either direction to rectify floor imperfections before a stub out is needed.
- Can be manufactured to fit most common slopes.
- Two strong (0.093) PVC panels are sandwiched between a Sound Dampening Technology core to help reduce sound and add strength.
- Easy to clean PVC Panels are available in multiple colors to complement your decor.
- **Optional accessories:** Top wire panel, side transfer door and stainless steel or tempered glass door.
- **Specs:** standard widths: 3', 3'6", & 4'; standard depth 8', 10', 12'; standard height: 6' on concrete (approx.), 6' 10" on raised floor (approx.).

Double Decker unit opening height 34" H,  
Single Kennel Height 6' H,  
overall height 6' (approx.) on concrete 6'10" (approx.) raised floor.

See "How to Buy T-Kennel Run Systems" on page 14 for outline of options and "Door Styles for T-Kennel Double Decker, Tri and Quad Kennels" on page 23.

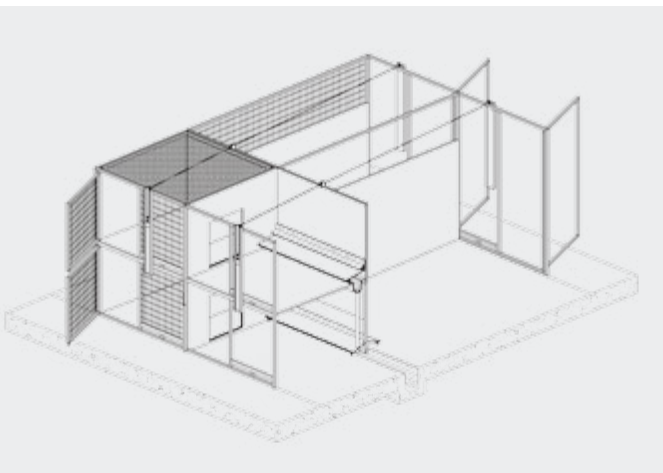
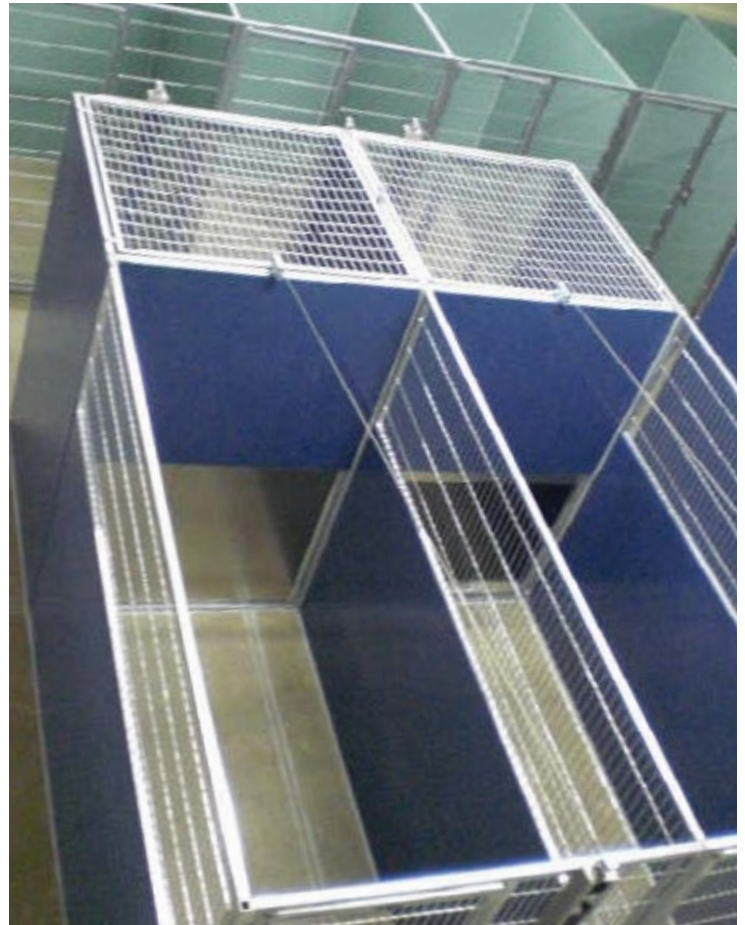

## T-KENNEL Quad Kennel

### Benefits:

The Quad Kennel System saves floor space while giving you the flexibility of stacked housing with the space of a kennel run. With the Double Decker Kennels back to back, a full width, counter-weighted, transfer door allows a pet to move freely between the lower units.

The top unit floor is 35" off the floor (if unit is ground level), so you are at about counter height. This works well in large areas in which you can move down one row tending to needs and back up the other side.

The Quad Kennel System can sit directly on the floor, or have a raised floor system with an integrated trench drain system covered by the full T-Cover for the lower kennel and two half T-Covers for the upper kennels.

### Features:

- The Quad Kennel has two separate top and bottom compartments on either side and is designed to provide maximum space.
- Frame is made up of 1" tubing, and wire is welded to the frame. Wire mesh top piece standard.
- Includes two slots per compartment for optional slide-in feed and water trays. Any kennel less than 4' wide will receive only one feed tray slot.
- Raised floor systems feature leveling legs and can run 32' in either direction to rectify floor imperfections before a stub out is needed.
- Four swing doors that open in or out.
- Includes a full width transfer door between the lower units operated by a counter-weighted pulley system.
- The upper floor drains are covered by two half T-Covers.
- The lower floor drains are covered by a full T-Cover that bridges the trench at the midsection to prevent cross-contamination when cleaning.
- Interconnecting drain systems permit up to 16 kennels (64 compartments) to share one centrally located drain outlet.
- Two strong (0.093) PVC panels are sandwiched between a Sound Dampening Technology core to help reduce sound and add strength.
- Easy to clean PVC Panels are available in multiple colors to complement your decor.
- **Optional accessories:** Side transfer door and stainless steel or tempered glass door.
- **Specs:** standard widths: 3', and 4'; standard depths: 6', 8'; each opening 34" high, overall height 6' (approx.) on concrete 6'10" (approx.) on raised floor.

See "How to Buy T-Kennel Run Systems" on page 14 for outline of options and "Door Styles for T-Kennel Double Decker, Tri and Quad Kennels" on page 23.

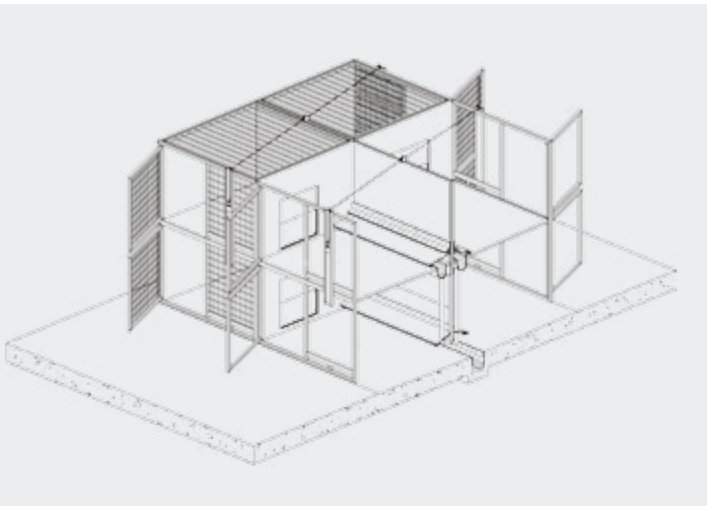



## DOOR STYLES FOR T-KENNEL DOUBLE DECKER, TRI AND QUAD KENNELS

### 1 Stainless Steel Doors and Gate Frame

Gate frame and gate panel are constructed of welded 1" stainless steel square tubing and stainless steel wire mesh. You can open the doors inward or outward for maximum flexibility.

### 2 Galvanized Doors and Gate Frame

Gate frame and gate panel are constructed of welded 1" square galvanized tubing and welded wire mesh. Both are hot-dip galvanized after fabrication for durability, strength and longevity. You can open the doors inward or outward for maximum flexibility.

### 3 Stainless Steel + Glass Doors and Gate Frame

Gate panel is constructed of welded 1" stainless steel square tubing and stainless steel wire mesh. The 23½"W by 32½"H doors are constructed of 1" stainless steel square tubing and ¼" tempered glass. You can open the 23½"W by 32½"H doors from either the inside or outside for maximum flexibility.



## KENNEL RUN ACCESSORIES

### Resting Bench for Runs

909.0067.00 14 lbs.

#### Benefits:

Allows pets a comfortable bed above a cold or wet run floor.

#### Features:

- Thermofomed, one-piece construction of high-density polyethylene.
- Surface has a comfortable, non-slip texture that is slightly crowned for fluid run-off.
- Specs: 40½"L x 22¼"W x 4"H.



### PVC Flip-Up Run Bench

Part number determined at time of order.

#### Benefits:

Perfect solution to provide a large dog resting area inside an existing run.

#### Features:

- Retrofits to most 36" or 48" kennels. If there is a trench drain in the back, the bench sits over the drain but does not interfere with it. It lifts up easily for hosing down the run.
- Available in various colors.
- Specs: 33¾"W x 22"L x 3"H and 45¾"W x 22"L x 3"H



# SPECIALTY KENNELS

## SHOR-LINE Folding Kennel

The Folding Kennel is a unique and groundbreaking concept in dog kenneling. You now have the ability to turn a room into a play area during the day and overnight accommodations in the evening.

Our Folding Kennel gives you a wall of kennels when it is unfolded and then folds up against a wall to a 7-inch footprint.

**Yes, 7 inches!**

**Specs:** Available opening sizes: 37½"W x 39"L or 49¾"W x 51"L.

Folding Kennel U.S. Patent #8,438,995

## A GREAT SPACE SAVER!

Customers who have purchased the Folding Kennel since it was introduced have found great uses for it.

- Can fold out one kennel at a time, maximizing floor space.
- Provides resting areas for dogs in daycare or safe "time out" room.
- Gives emergency kennels for overflow boarding times.
- Offers flexible multi-purpose housing for special services (grooming, dog training, physical therapy).



This facility made use of a narrow area.



When not in use, the kennels stay tucked away.

Store against the wall; 7" footprint



You have the option of opening up just one or two rooms.

Pull out just one room...



...or two rooms while others stay against the wall



Fully unfolded, the kennel is approximately 3'W x 3'L or 4'W x 4'L.



## Barkolyn Boudoir Dutch Door Kennel™ *New!*

Part number determined at time of order.

### Benefits:

Dogs are living the "suite" life with an extra large, home-style kennel complete with a tempered glass Dutch door you can open part way or close tight. You can chose colored panels to decorate in style.

Your contractor can add drywall to make the kennel a floor-to-ceiling room.

### Features:

- Extra sturdy 1½" square stainless steel tube door frame.
- Tempered glass Dutch door with glass encased in aluminum extrusion.
- Optional smoked glass for lower door.
- Add a Resting Bench for luxury sleeping. See page 23.
- Choice of tempered glass or colorful PVC panels on side and back door.
- Optional accessories: swivel feeder.
- **Specs:** standard widths: 4' or 5' W; standard depths: 6' or 8'; overall height 6'6" (approx.) on concrete 7'4" (approx.) raised floor.



## Puppy Kennel

Part number determined at time of order.

### Benefits:

Shor-Line's Puppy Kennel gives puppies the "big dog" experience. The double decker unit has a carabiner pulley system that opens and shuts a transfer gate that allows puppies to travel horizontally. You can close the gate for cleaning.

### Features:

- Frame is 1" square tubing and wire is welded to the frame.
- Includes top welded steel mesh piece.
- Two carabiner-style pulleys independently operate each transfer door.
- Transfer aluminum doors are 12"W x 14"H.
- Insulated PVC panels in a variety of colors. (See page 5.)
- Four units with interior space 34"W x 25"L x 31"H.
- **Specs:** Exterior 73"W x 27"L x 66"H



## NEW GLASS ACCESSORIES

### Cage Valet

- 915.0200.11 Small 5½"W x 10½"H x 3"D 1 lb.
- 915.0200.10 Large 9" W x 15"H x 3"D 2 lb.

### Benefits:

Holds medications, toys, collars, leads, ID cards and notes.

### Features:

- Four suction cups hold valet securely to the glass.
- Stainless Steel tension clip secures your patient's paperwork.
- Polycarbonate material is crack- and shatter-resistant.

### Kennel Gear™ Adhesive Bowl System

- 041.0017.103 1 pint bowl 2 lbs.
- 041.0017.104 1 pint double bowl 2 lbs.
- 041.0017.105 1 quart bowl 2 lbs.

### Benefits:

Provides a secure feeding system that attaches to glass kennel fronts.

### Features:

- Easily applies to clean, dry glass or PVC surfaces. Bond pressure improves when you apply moderate heat and pressure.
- Accepts standard Kennel Gear™ bowls when set.



## KENNEL FEEDER SYSTEMS

### Shor-Line Swivel Feeder *New!*

Part number determined at time of order.

#### Benefits:

Makes quick work of feeding and watering animals. Simply place the food and water in the holders at the correct height and swivel the items into the kennel. Lock in place.

#### Features:

- Made of durable stainless steel.
- Fits 21¾"W x 10½"H opening.
- For Shor-Line kennels, choose between Options A, B or C. For T-Kennel, chose Option B or C.

**Option A** – Feeder system with 2-Quart Double Bowl;

**Option B** – Feeder system with 1-Quart Double Bowl system;

**Option C** – Feeder System with 4-Quart pail and 1-Quart bowl.

**Note:** These feeders can't retrofit, they must be ordered when kennel is built.

#### OPTION A



2-Quart Double Bowl

#### OPTION B



1-Quart Double Bowl

#### OPTION C



1 4-Quart Pail and 1-Quart Bowl

### Shor-Line Slide-In Vertical Feeder System *New!*

809.0012.01 Double Bowl, Vertical 4 lbs.

#### Benefits:

This provides an economical, time-saving option for a kennel feeder system. The feeding slots will be built slightly larger to accommodate a slide-in 2-Quart double bowl feeding system. It locks into position for feeding and the slides out again for easy clean-up.

#### Features:

- ONLY available on NEW T-Kennel purchases of 36"W or larger.
- Includes two durable 2-Quart stainless steel bowls.



### Shor-Line Slide-In Horizontal Feeder System *New!*

809.0012.00 Double Bowl, Horizontal 2.5 lbs.

#### Benefits:

This provides an economical, time-saving option for a kennel feeder system. The feeding slots will be built slightly larger to accommodate a slide-in 2-quart double bowl feeding system. It locks into position for feeding and the slides out again for easy clean-up.

#### Features:

- ONLY available on NEW T-Kennel purchases of 48"W or larger.
- Includes two durable 2-Quart stainless steel bowls.



### Kennel Gear™ Versa Feeder

041.0017.64

#### Benefits:

Convenient swivel feeding system swivels 180 degrees for you to attach filled food and water containers and then swivels another 180 degrees to lock into the opening so the pets can eat and drink.

#### Features:

- Made of aluminum.
- Fits 21¾"W x 10½"H opening.
- Works with range of pails and bowls that are sold separately (See page 49)



### Shor-Line Stainless Steel Feed Tray

041.0018.03 3 lbs.

#### Benefits:

The Feed Tray keeps food in the tray and makes feeding easy. Just slide in and pull out. Only available on T-Kennel doors.

#### Features:

- Made of durable stainless steel.
- Slides into feed slot in T-Kennel kennels.
- You can fill and clean without entering the kennel.
- **Specs:** 8"W x 9.625"L x 1.813"D.

# CAGES

Shor-Line began making animal cages mid-century to meet the needs of veterinarians. We have continued to improve our animal cages, evolving with veterinary, boarding and shelter professionals.

If you need cages, we can find a solution! Our standard cages are made in 6" increments, starting with 18"W x 18"H. All cages are 28 1/4" deep, not including the latch. Your best value comes with purchasing standard sizes, but if you can dream it, we can build it.

Our cages are often handed down from practice to practice because they are so durable. There is a reason why animal professionals have been purchasing our cages for almost **seven** decades.



48"W x 30"H  
Double Door Cage

# BENEFITS OF A DOUBLE DOOR CAGE

Looking for a housing solution for your large dogs? Try our Double Door (DD) cage. **It comes in a variety of sizes with these features:**

- 48", 60" or 72"W
- 24", 30" or 36"H
- Removable middle cage post adds strength and integrity when securing the latch, but it also allows for easy opening.
- Removing the cage post allows you to slide in a recombinant patient.
- Insert cage divider to house more smaller animals. We designed the cage to provide a secure environment when you divide the cage.
- Patented Hinge Design U.S. Patent #7,805,808

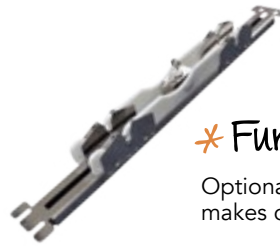

\* Further reduce animal stress

Optional Quiet Closing Latch makes cage closing near silent.

# ANATOMY OF A: CAGE

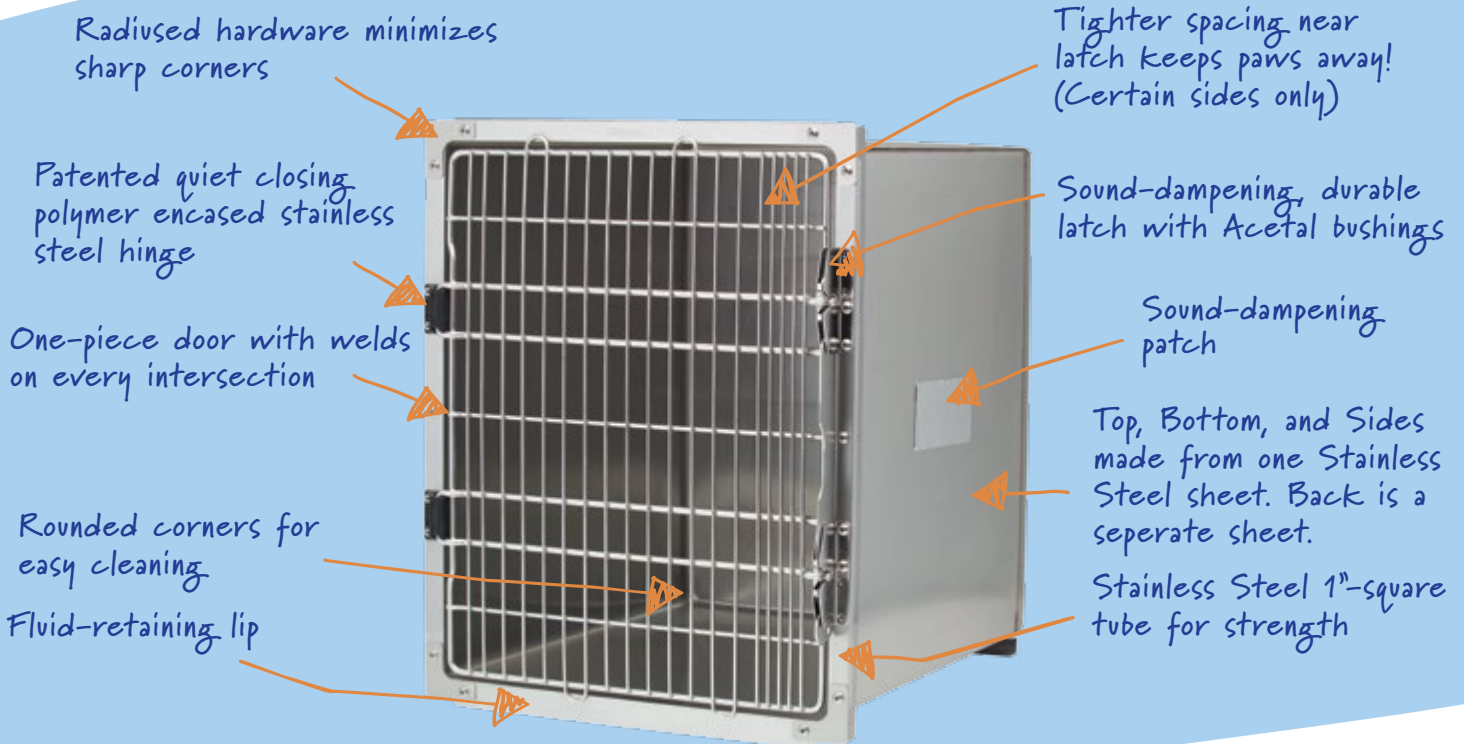

## 4' STAINLESS STEEL CAGE ASSEMBLIES



### 4' Assembly, Option A

902.0103.19 180 lbs.

Top: 2 - 24"W x 24"H cages  
Bottom: 1 - 48"W x 30"H double door cage

**With Platforms:**

Mobile #902.0103.20 200 lbs.  
Stationary #902.0103.21 198 lbs.



### 4' Assembly, Option B

902.0103.16 204 lbs.

Top: 2 - 24"W x 30"H cages  
Bottom: 1 - 48"W x 30"H double door cage

**With Platforms:**

Mobile #902.0103.17 224 lbs.  
Stationary #902.0103.18 222 lbs.



### 4' Assembly, Option C

902.0105.33 350 lbs.

Top: 2 - 24"W x 24"H cages  
Middle: 2 - 24"W x 18"H cages  
Bottom: 1 - 48"W x 30"H double door cage

**With Platforms:**

Mobile #902.0105.34 370 lbs.  
Stationary #902.0105.35 368 lbs.

## 6' STAINLESS STEEL CAGE ASSEMBLIES

\* Most popular assembly!



### 6' Assembly, Option A

902.0105.36 314 lbs.

Top: 3 - 24"W x 30"H cages  
Bottom: 2 - 36"W x 30"H cages

**With Platforms:**

Mobile #902.0105.37 345 lbs.  
Stationary #902.0105.38 343 lbs.



### 6' Assembly, Option B

902.0105.39 354 lbs.

Top: 2 - 36"W x 30"H cages  
Bottom: 1 - 72"W x 36"H double door cage

**With Platforms:**

Mobile #902.0105.40 385 lbs.  
Stationary #902.0105.41 383 lbs.



### 6' Assembly, Option C

902.0105.42 318 lbs.

Top: 3 - 24"W x 24"H cages  
Bottom: 1 - 48"W x 30"H double door cage  
1 - 24"W x 30"H cage

**With Platforms:**

Mobile #902.0105.43 349 lbs.  
Stationary #902.0105.44 347 lbs.



## 5' STAINLESS STEEL CAGE ASSEMBLIES



### 5' Assembly, Option A

902.0104.19 252 lbs.

Top: 2 - 30"W x 30"H cages  
Bottom: 2 - 30"W x 30"H cages

#### With Platforms:

Mobile #902.0104.20 275 lbs.  
Stationary #902.0104.21 273 lbs.



### 5' Assembly, Option B

902.0104.22 212 lbs.

Top: 2 - 30"W x 24"H cages  
Bottom: 1 - 60"W x 36"H double door cage

#### With Platforms:

Mobile #902.0104.23 235 lbs.  
Stationary #902.0104.24 233 lbs.



### 5' Assembly, Option C

902.0104.25 212 lbs.

Top: 2 - 30"W x 24"H cages  
Middle: 2 - 30"W x 24"H cages  
Bottom: 2 - 30"W x 30"H cages

#### With Platforms:

Mobile #902.0104.26 235 lbs.  
Stationary #902.0104.27 233 lbs.

## 7' STAINLESS STEEL CAGE ASSEMBLIES



### 7' Assembly, Option A

902.0106.16 385 lbs.

Top: 2 - 30"W x 30"H cages, 1 - 24"W x 30"H cage  
Bottom: 1 - 48"W x 30"H DD cage, 1 - 36"W x 30"H cage

#### With Platforms:

Mobile #902.0106.17 419 lbs.  
Stationary #902.0106.18 417 lbs.



### 7' Assembly, Option B

902.0106.19 377 lbs.

Top: 2 - 30"W x 30"H cages, 1 - 24"W x 30"H cage  
Bottom: 1 - 36"W x 30"H cage, 2 - 24 x 30"H cages

#### With Platforms:

Mobile #902.0106.20 411 lbs.  
Stationary #902.0106.21 409 lbs.

## 8' STAINLESS STEEL CAGE ASSEMBLIES



### 8' Assembly, Option A

902.0109.16 378 lbs.

Top: 4 - 24"W x 24"H cages  
Bottom: 2 - 36"W x 30"H cages, 1 - 24"W x 30"H cage

#### With Platforms:

Mobile #902.0109.17 413 lbs.  
Stationary #902.0109.18 411 lbs.



### 8' Assembly, Option B

902.0109.19 436 lbs.

Top: 4 - 24"W x 24"H cages  
Bottom: 2 - 48"W x 30"H DD cages

#### With Platforms:

Mobile #902.0109.20 471 lbs.  
Stationary #902.0109.21 469 lbs.

## 9' STAINLESS STEEL CAGE ASSEMBLIES



### 9' Assembly, Option A

902.0110.19 496 lbs.

Top: 3 - 36"W x 30"H cages  
Bottom: 1 - 72"W x 36"H DD cage, 1 - 36"W x 36"H cage

#### With Platforms:

Mobile #902.0110.20 542 lbs.  
Stationary #902.0110.21 539 lbs.



### 9' Assembly, Option B

902.0110.22 456 lbs.

Top: 2 - 30"W x 30"H cages, 2 - 24"W x 30"H cages  
Bottom: 1 - 48"W x 30"H DD cage, 2 - 30"W x 30"H cages

#### With Platforms:

Mobile #902.0110.23 494 lbs.  
Stationary #902.0110.24 492 lbs.



### 8' Assembly, Option C

902.0109.22 562 lbs.

Top: 4 - 24"W x 24"H cages  
 Middle: 2 - 36"W x 30"H cages, 1 - 24"W x 30"H cage  
 Bottom: 2 - 48"W x 30"H DD cages

#### With Platforms:

Mobile #902.0109.23 597 lbs.  
 Stationary #902.0109.24 595 lbs.

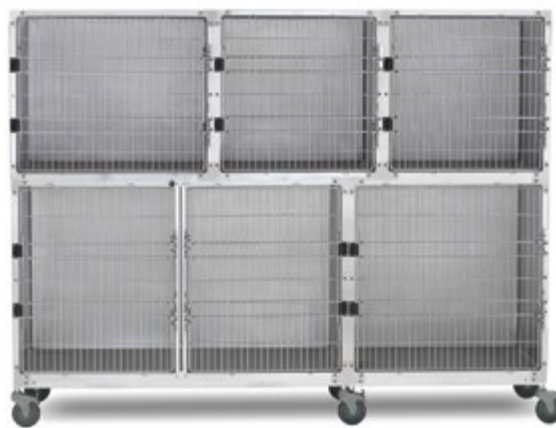

### 8' Assembly, Option D

902.0109.25 450 lbs.

Top: 1 - 36"W x 30"H cage, 2 - 30"W x 30"H cage  
 Bottom: 1 - 60"W x 36"H DD cage, 1 - 36 x 36"H cages

#### With Platforms:

Mobile #902.0109.26 487 lbs.  
 Stationary #902.0109.27 485 lbs.

## STANDARD INDUSTRY CAGE SIZES

ITEM NUMBER	SIZE (WxH)	SHIPPING WEIGHT
902.1818.70	18" x 18"	34 lbs.
902.1824.70	18" x 24"	40 lbs.
902.2418.70	24" x 18"	42 lbs.
902.2424.70	24" x 24"	47 lbs.
902.2430.70	24" x 30"	56 lbs.
902.2436.70	24" x 36"	63 lbs.
902.3024.70	30" x 24"	56 lbs.
902.3030.70	30" x 30"	64 lbs.
902.3036.70	30" x 36"	73 lbs.
902.3624.70	36" x 24"	70 lbs.
902.3630.70	36" x 30"	73 lbs.
902.3636.70	36" x 36"	79 lbs.
902.4230.70 SD	42" x 30"	79 lbs.
902.4236.70 SD	42" x 36"	83 lbs.
902.4830.70 SD	48" x 30"	92 lbs.
902.4830.73 DD	48" x 30"	95 lbs.
902.4836.70 SD	48" x 36"	101 lbs.
902.4836.73 DD	48" x 36"	103 lbs.
902.6036.73 DD	60" x 36"	162 lbs.
902.7236.73 DD	72" x 36"	198 lbs.

SD: Single Door DD: Double Door



### 9' Assembly, Option C

902.0110.25 619 lbs.

Top: 2 - 30"W x 24"H cages, 2 - 24"W x 24"H cages  
 Middle: 2 - 30"W x 24"H cages, 2 - 24"W x 24"H cages  
 Bottom: 3 - 36"W x 30"H cages

#### With Platforms:

Mobile #902.0110.26 665 lbs.  
 Stationary #902.0110.27 662 lbs.

## 10' STAINLESS STEEL CAGE ASSEMBLIES



### 10' Assembly, Option A

902.0112.13 576 lbs.

Top: 4 - 30"W x 30"H cages  
Bottom: 2 - 60"W x 36"H DD cages

#### With Platforms:

Mobile #902.0112.14 617 lbs.  
Stationary #902.0112.15 615 lbs.



### 10' Assembly, Option B

902.0112.16 743 lbs.

Top: 5 - 24"W x 24"H cages  
Middle: 4 - 30"W x 24"H cages  
Bottom: 1 - 72"W x 36"H cage, 1 - 48"W x 36"H DD cage

#### With Platforms:

Mobile #902.0112.17 790 lbs.  
Stationary #902.0112.18 787 lbs.

## 12' STAINLESS STEEL CAGE ASSEMBLIES



### 12' Assembly, Option A

902.0114.13 664 lbs.

Top: 4 - 30"W x 30"H cages, 1 - 24"W x 30"H cage  
Bottom: 1 - 72"W x 36"H DD cage, 2 - 36"W x 36"H cage

#### With Platforms:

Mobile #902.0114.14 722 lbs.  
Stationary #902.0114.15 719 lbs.



### 12' Assembly, Option B

902.0114.16 848 lbs.

Top: 6 - 24"W x 24"H cages  
Middle: 4 - 30"W x 30"H cages, 1 - 24"W x 30"H cage  
Bottom: 3 - 48"W x 30"H DD cages

#### With Platforms:

Mobile #902.0114.17 899 lbs.  
Stationary #902.0114.18 896 lbs.





### 10' Assembly, Option C

902.0112.19 710 lbs.

Top: 5 - 24"W x 24"H cages  
 Middle: 4 - 30"W x 30"H cages  
 Bottom: 1 - 48"W x 30"H DD cage, 2 - 36 x 30"H cages

#### With Platforms:

Mobile #902.0112.20 757 lbs.  
 Stationary #902.0112.21 754 lbs.



## 14' STAINLESS STEEL CAGE ASSEMBLIES

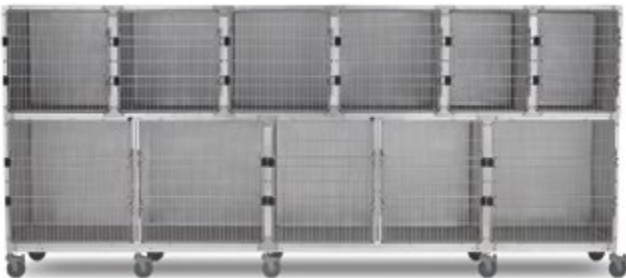

### 14' Assembly, Option A

902.0117.13 813 lbs.

Top: 4 - 30"W x 30"H cages, 2 - 24"W x 30"H cages  
 Bottom: 1 - 72"W x 36"H DD cage, 1 - 60"W x 36"H DD cage,  
 1 - 36"W x 36"H cage

#### With Platforms:

Mobile #902.0117.14 877 lbs.  
 Stationary #902.0117.15 874 lbs.



### 14' Assembly, Option B

902.0117.16 1002 lbs.

Top: 7 - 24"W x 24"H cages  
 Middle: 4 - 30"W x 30"H cages, 2 - 24"W x 30"H cages  
 Bottom: 2 - 48"W x 30"H DD cages, 2 - 36"W x 30"H cages

#### With Platforms:

Mobile #902.0117.17 1064 lbs.  
 Stationary #902.0117.18 1061 lbs.

## SPECIALTY CAGES

### Isolation/Parvo Cage

925.3931.01	Isolation/Parvo Cage	130 lbs.
925.2000.02	Upper Isolation/Parvo Cage	130 lbs.
925.2000.03	2 Unit Isolation/Parvo Cage	260 lbs.

#### Benefits:

Isolates potentially infectious patients from healthy patients and uses a unique drainage system that makes clean-up fast and easy.

#### Features:

- Easy-to-clean, disinfectant safe polyethylene cage shell.
- Raised floor system keeps the patient elevated, minimizing contact with their waste.
- Lexan door splatter guard and raised bottom retaining lip help to contain liquids.
- Sloped rear drainage system.
- **Interior dimensions:** 35"W x 27½"H x 28"D.
- **Exterior dimensions:** 38¾"W x 31"H x 34"D (including drain).



### Mobile Transport Unit

902.0001.50	40¾"W x 38"H x 30¾"D	119 lbs.
-------------	----------------------	----------

#### Benefits:

Mobility and design allow this unit to be used for receiving and releasing patients, moving them, as a temporary holding kennel, or even as an emergency exam and treatment table.

#### Features:

- Built like the Shor-Line modular cages, the mobile transport unit is insulated and finished with polished stainless steel side and top panels.
- The universal door is designed for right-hand or left-hand opening.
- Large 5" heavy-duty corrosion resistant casters let you maneuver the unit easily through most door openings.
- All casters feature locking mechanisms to hold the unit stationary when not in use.
- Full width bar handle for easy control.



## MORE CAGE OPTIONS!

### Glass Back Cage (Shown at left) Pass-Thru Perforated Floor and Pan and more!

Contact us for all your unique housing needs.  
Our custom design service offers an array of housing options.



Glass Back Cage



Perforated Floor and Pan

# PLASTIC CAGES

## Standard Plastic Cages

925.1000.02	2 Unit Assembly	175 lbs.
925.3000.02	3 Unit Assembly	160 lbs.
925.4000.02	4 Unit Assembly	148 lbs.
925.6000.02	6 Unit Assembly	222 lbs.
925.1000.11	2 Unit Assembly with Floor and Pans	190 lbs.
925.3000.12	3 Unit Assembly with Floor and Pans	163 lbs.
925.4000.12	4 Unit Assembly with Floor and Pans	152 lbs.
925.6000.12	6 Unit Assembly with Floor and Pans	244 lbs.
925.2430.02	Medium Cage	42 lbs.
925.4836.03	Large Cage	86 lbs.
925.2430.12	Medium Cage with Floor and Pan	51 lbs.
925.4836.13	Large Cage with Floor and Pan	85 lbs.

### Benefits:

A cost-effective alternative approach to animal cages, the plastic cages are corrosion-resistant and constructed of technologically advanced materials for durability and sanitation. More durable and serviceable than fiberglass or wood/laminate dog cages.

### Features:

- One piece, rotationally molded polyethylene eliminates stress points and adds overall uniformity and rigidity.
- Plastic material resists stains, daily exposure to disinfectants and makes clean up a snap.
- Urine retaining lip catches spills.
- Stainless steel doors and hardware.
- Optional raised PVC coated floors and high impact, polystyrene pans available.
- Medium cage: 24 $\frac{1}{4}$ "W x 32 $\frac{5}{16}$ "H x 28 $\frac{3}{4}$ "D.
- Large cage: 48 $\frac{1}{2}$ "W x 34 $\frac{1}{2}$ "H x 28 $\frac{3}{4}$ "D.
- Platforms sold separately.
- See "High Impact Pans for Plastic Cages" on page 36.



925.6000.12  
(Floors and pans included)



925.3000.02  
3-Unit Assembly



925.4000.12  
(Floors and pans included)



925.1000.02  
2-Unit Assembly

(See platform options on page 36)

## CAGE ACCESSORIES



### Divider for Large Plastic Cages

314.0535.01	Large Cage	14 lbs.
314.0535.00	Large Cage with Floor+Pan	14 lbs.

#### Benefits:

This removable cage divider converts a large cage into two medium cages. Works with Plastic Cages (page 35).

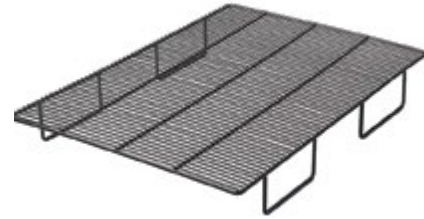

### PVC Coated Floors for Plastic Cages

725.2128.01	With Legs for Medium Cage	12 lbs.
725.2128.00	Without Legs for Medium Cage with Floor + Pans	10 lbs.

#### Benefits:

Raised floors slide into cage bottom, helping to keep patients clean and dry. Works with Plastic Cages only. (page 35).



### High Impact Pan for Plastic Cages

181.0018.00	6 lbs.
-------------	--------

#### Benefits:

Plastic cage pan makes cleanup simple and fast without disturbing the patient. Works with Plastic Cages only. (page 35).

#### Features:

- Made of polystyrene.
- Ideal for patients experiencing containment problems.
- Fits below cage floor to collect fluids and waste from patients.



### Platform for Plastic Cages

825.4800.00	48" Platform for Plastic Cages	24 lbs.
825.7200.00	72" Platform for Plastic Cages	31 lbs.
086.5012.11	Caster with Brake	5 lbs.
702.0004.00	Leveling Leg Adapter	2 lbs.

#### Benefits:

Casters provide easy maneuverability that aids in cleaning and bank rearranging. Adjustable feet in each leveling leg allows for easy leveling. Works with Plastic Cages (page 35).

#### Features:

- Platform comes in a black powder coat finish for durability.
- Choose 5" corrosion proof reinforced nylon locking casters with polyurethane wheels that will not "flat spot" or mar floors OR stainless steel leveling legs to complete your platform purchase.



### Stainless Steel Litter Pans

190.9000.13	12¾"W x 20¾"L x 4"H	4 lbs.
190.9000.08	12¾"W x 10¾"L x 2½"H	2 lbs.

#### Benefits:

Heavy-gauge stainless steel to provide easy care and cleanup.



### Cat Lounging Bench

802.0005.00	Cat Lounging Bench	2 lbs.
-------------	--------------------	--------

#### Benefits:

High sides help felines crouch down and feel safe.

#### Features:

- Made of durable, easy-to-clean polyethylene in a light gray color.
- High sides help retain body heat to help cats feel warm.
- Specs: 11½"W x 21"L x 4"H.





### Mobile Platform for Stainless Steel Cages

See standard cage assemblies for applicable item numbers or call to speak with a sales representative about a custom configuration.

**Benefits:**

Platform provides easy maneuverability that aids in cleaning and bank rearranging. Easier access to bottom level cages.

**Features:**

- Large reinforced nylon casters and polyurethane wheels that will not "flat spot" or mar floors. Rotates 360° for easy maneuverability.
- All casters feature locking mechanisms to hold your kennel assembly stationary between moves.
- Allow 8½" height increase for mobile platforms when planning your space requirements.
- 086.5012.11 Caster with Brake.

\* Height Reducing Platform available upon request. Recessed casters reduce overall height by about 4"



### Stationary Platform for Stainless Steel Cages

See standard cage assemblies for applicable item numbers or call to speak with a sales representative about a custom configuration.

**Benefits:**

Allows cleaning under cages and raises bottom cages to an easier access level.

**Features:**

- Adjustable feet in each leg easily facilitates leveling.
- For planning purposes, allow for a 9¼" height increase when adjustable feet are fully extended and an 8" height increase when they are not extended.
- 702.0004.00 Leveling Leg Adapter.

### End & Top Panels for Stainless Steel Cages

802.0018.51	End Panels for 18"H Cage	10 lbs.
802.0024.51	End Panels for 24"H Cage	12 lbs.
802.0030.51	End Panels for 30"H Cage	14 lbs.
802.0036.51	End Panels for 36"H Cage	16 lbs.
802.1800.00	Top Panel for 18" Cage	10 lbs.
802.2400.00	Top Panel for 24" Cage	12 lbs.
802.3000.00	Top Panel for 30" Cage	14 lbs.
802.3600.00	Top Panel for 36" Cage	16 lbs.
802.4800.00	Top Panel for 48" Cage	18 lbs.
802.6000.00	Top Panel for 60" Cage	20 lbs.
802.7200.00	Top Panel for 72" Cage	23 lbs.

**Benefits:**

Top and End Panels are the easiest way to give your individual cage or cage assemblies an attractive, one piece finished look.

**Features:**

- Constructed of the same high-quality stainless steel used on the cage itself.
- End and Top Panels are ordered separately and are easily attached at your facility.



### Cage Valets

915.0200.04	Small 10½"H x 5½"W x 3"D	1 lb.
915.0200.05	Large 15"H x 9"W x 3"D	2 lbs.

**Benefits:**

Holds medications, toys, collars, leads, ID cards and forms.

**Features:**

- Stainless steel tension clip secures your patient's paperwork.
- Polycarbonate material is crack and shatter resistant.

(See Glass Cage Valets on Page 25)



### Divider for Stainless Steel Double Door Cages

802.0024.00	24" H Double Door Cage	12 lbs.	29"W x 21"H
802.0030.00	30" H Double Door Cage	14 lbs.	29"W x 27"H
802.0036.00	36" H Double Door Cage	17 lbs.	29"W x 33"H

#### Benefits:

There are now two options for cage dividers--Stainless Steel or heavy duty ABS. Both cage dividers provide a quick, affordable method to convert 48", 60" and 72" wide double door Shor-Line cage into two smaller units.

#### Stainless Steel Divider Features:

- Provides heavy-gauge Stainless Steel construction.
- The double-door latch system removes quickly and easily when you need to slide a large patient in or out of the cage.
- The bracket at the back of the cage holds the door snug to maintain secure separation between the cage spaces.



802.0030.00

**NEW!**

### Thermal Formed ABS Divider

802.0030.01	30" H Double Door Cage	12 lbs.	30½" W x 27"H
802.0036.01	36" H Double Door Cage	16 lbs.	30.688 W x 33"H

#### ABS Divider Features:

- The ABS divider provides lightweight durability and cleaning ease.
- The formed handle makes one-handed opening and closing easy.



802.0030.01

### PVC Coated Cage Floors for Stainless Steel Cages

317.0098.00	Floor, 18"W Cage	11 lbs.
317.0098.01	Floor, 24"W Cage	20 lbs.
317.0098.02	Floor, 30"W Cage	25 lbs.
317.0098.03	Floor, 36"W Cage	28 lbs.
317.0098.04	Floor, 48"W Single Door Cage	33 lbs.
317.0098.05	Floors, 48"W Double Door Cage (2 pieces*)	41 lbs.
317.0098.45	Floors, 60"W Double Door Cage (2 pieces*)	51 lbs.
317.0098.46	Floors, 72"W Double Door Cage (2 pieces*)	57 lbs.

#### Benefits:

Keeps patients dry and clean.

#### Features:

- 14 gauge perforated sheet steel.
- Openings are approximately  $\frac{3}{8}$ " diameter after PVC coating.
- Non-toxic PVC coating is approximately  $\frac{1}{8}$ " thick and seals entire floor.
- Floor height is approximately  $2\frac{1}{4}$ ".

\* These cages require 2 pieces. Part numbers above are 1 piece; they are Double Door cages.



### Squeeze Restraint

924.0200.00	24" x 18" cage	19 lbs.
924.0200.01	24" x 24" cage	22 lbs.
924.0200.02	24" x 30" cage	25 lbs.
924.0200.03	30" x 30" cage	29 lbs.

#### Benefits:

Puts non-cooperative patients in a secure but tighter space, creating a safer vaccination and treatment environment.

#### Features:

- The squeeze mechanism is designed with two 1" diameter stainless steel handles affixed to a wire door panel, similar to our cage doors.
- The push/pull system allows the squeeze restraint to gently ease the patient to the front of the cage for treatment.
- When the wire door panel is pushed to the back of the cage, the handles discreetly blend in with the cage frame.



Cage closed



### Stainless Steel Card Holders

802.0000.01	3"H x 5"W	1 lb.
802.0000.02	5"H x 8"W	1 lb.

**Benefits:**

Quickly and easily identify your patients at a glance.

**Features:**

- Three-sided pocket holds an index card in place.
- Twist and turn method attaches holders easily to the horizontal bar of Shor-Line and most other wire cage doors.



### Record Holders

802.0010.05	5½"W x 8¼"H Tension Clip	1 lb.
802.0010.06	9"W x 12¼"H Tension Clip	2 lbs.

**Benefits:**

Quickly and easily identify your patients at a glance.

**Features:**

- Twist and turn method attaches holders easily to the horizontal bar of Shor-Line and most other wire cage doors.
- Holders keep patient records securely attached to cage or kennel doors.

### Quiet-Time Cage Door Cover

179.2424.00	24"W x 24"H Cage Door	1 lb.
179.2430.00	24"W x 30"H Cage Door	1 lb.
179.3030.00	30"W x 30"H Cage Door	1 lb.
179.3630.00	36"W x 30"H Cage Door	1 lb.

**Benefits:**

Instead of hanging old towels over your cage doors to calm aggressive or nervous dogs use Shor-Line Quiet-Time Cage Door Covers. Most dogs stop their nuisance barking when you block their visibility of people and other animals. Quiet-Time Cage Door Covers provide some isolation and solitude for patients during treatment or recovery.

**Features:**

- Color-fast blue nylon construction is stain and snag resistant.
- 3" deep pocket fits snugly over the top of door and secured with plastic snaps.
- Clear vinyl window to display client/patient information.
- Machine washable.



Cover folded halfway

### Shor-Shelf® Cat Perching Shelf for Stainless Steel Cages

802.0006.00	4 lbs.
-------------	--------

**Benefits:**

The removable Shor-Shelf® allows cats to follow their natural instinct to jump and perch above the floor.

**Features:**

- The shelf is 7" deep and adjusts to fit all 18", 24" and 30" wide cages.
- Unique flex-ends with special non-slip pads automatically adjust to taper of kennel—no drilling or modification of cage required.





## CAT CONDOS AND SUITES

Cat condos and suites reduce stress on cats because you are getting the bathroom out of the living area. Our suites give cats a separate litter area. Use the "How to Buy" guide on the next page to plan your new cat housing unit.

\* New ventilation!



Bottom Storage

## THE DIFFERENCE BETWEEN A CONDO AND A SUITE

Our Cat Condos include a 24" or 30" wide living area with a resting shelf. It also includes a horizontal portal that you can open to allow a cat to travel from its condo to an adjacent unit. This allows you to turn any two condos into a large Suite. The horizontal plug cover pulls through easily so you can adjust it open or closed from the outside.

So what makes a unit a Suite? Our Shor-Line Cat Suites include both a 24" or 30" wide living area with a resting shelf PLUS two 12" or 18" wide litter, bedroom or storage areas. Our flexibility and versatility with our pass throughs and transfers provides minimal feline handline and maximizes staff usage.

## GOT STORAGE?

Many of our customers regret not building more storage into units. The cat condos have plenty of opportunities to store special diets, personal toys and other items you need handy.

- **Bottom storage:** Add an extra foot or two of storage with either doors or drawers. Available in 12", 24" and 30" high.
- **Side storage:** A laminate face hides the contents. It typically is above the litter area. Available in 9" or 15" high.





# HOW TO BUY MODULAR CAT CONDOS + SUITES

## MATERIAL



**Stainless Steel Cat Suite**  
Best for long-term housing. Can be easily disinfected. Durable material that can provide the same space options as laminate but will last longer. See page 47 for buying options.

**Multi Colored Laminate**  
Solid moisture-resistant board (MRB) with thermally fused, high-pressure Multi-Colored Laminate. Saturating with water, cleaning solutions or urine may degrade surface over time. See below for buying options.

## CONDO SIZES

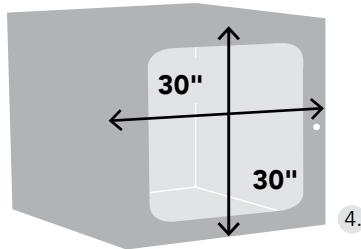
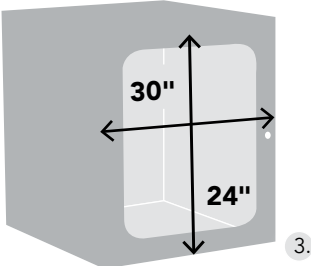
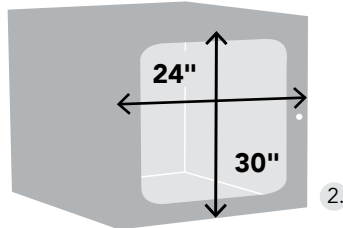
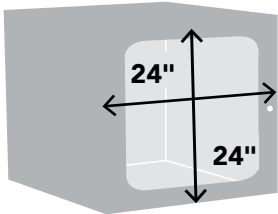

1.  24W" x 24H"
2.  24W" x 30H"
3.  30W" x 24H"
4.  30W" x 30H"

\* All Multi-Colored Laminate condos are 25¼" deep, not including the latch on the inside, and 26½" deep, not including the latch on exterior.

30"W x 40"H special order condos available.

Stack several to create an assembly.

## DOORS

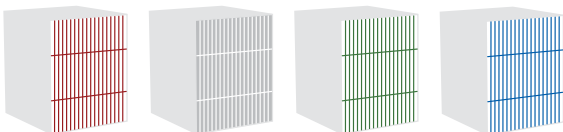
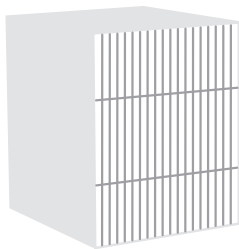

**Acrylic**  
See-through door lets you easily view your boarders. Ventilation slits are easy to clean. Push in and pop out locking door keeps cat secure.

**Stainless Steel**  
Solid stainless steel door frame is 5/16" diameter. We weld vertical and horizontal rods to the frame and at every intersection. To keep curious paws away, we decrease the vertical rod spacing to 1/2" around the latch. Opens easily with an elbow or knee, so you can keep your hands on the cat.

**Powder-Coated Stainless Steel**  
Choose from Burgundy, White, Royal Blue and Hunter Green..

## BACK PANELS

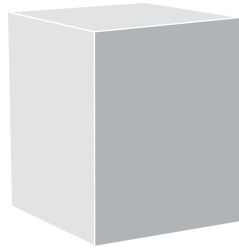

Acrylic



Solid

## PASS THROUGHS

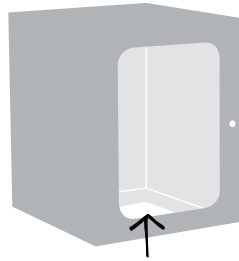
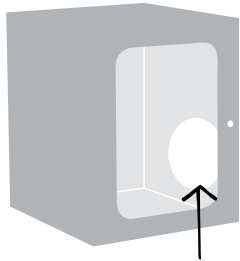

Side-to-Side

Horizontal pass through allows two cats to share units. You can open and close the portal without opening the unit by pulling out the divider. Create a play area for your cats by connecting several units.



Bottom-to-Top

An additional opening allows for vertical travel between condos or you can close it with a removable, lockable polyethylene "plug." You choose how many condos you connect.

## LITTER AND STORAGE

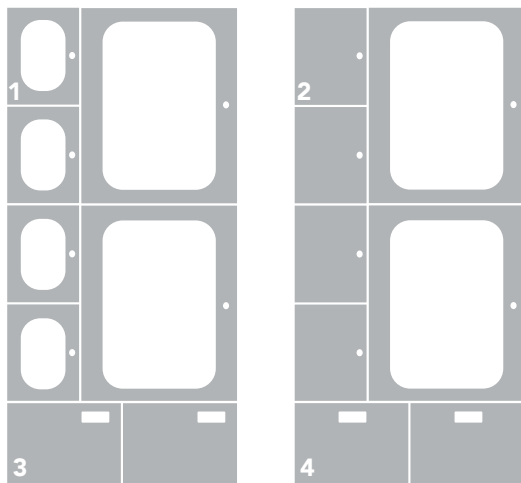

- 1 Litter/Bedroom  
Always 15"H;  
12" or 18"W
- 2 Side Storage  
9" or 15"H;  
12" or 18"W
- 3 Door Storage  
12", 18" or 24"H;  
Fits at bottom of  
assembly.
- 4 Drawer Storage  
12", 18" or 24"H;  
Fits at bottom of  
assembly.

## PLATFORM



Mobile



Stationary

## LAMINATE COLORS

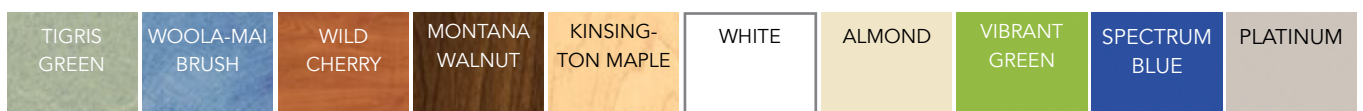

Optional Wilson Art® and Formica® colors are available and some color choices are subject to additional charges and or increased lead times. Interior is always white.

# STANDARD CAT CONDO + SUITE ASSEMBLIES



### 3' Wide Cat Suite

923.0030.10 386 lbs.

2 - 24"W x 30"H Condos with 12"W Left Hand Litter/Bedroom

**With Platforms:**

Mobile #923.0030.11  
Stationary #923.0030.12



### 3 1/2' Wide Cat Suite

923.0038.10 415 lbs.

2 - 24"W x 30"H Condos with 18"W Left Hand Litter/Bedroom

**With Platforms:**

Mobile #923.0038.11  
Stationary #923.0038.12



### 3 1/2' Wide Cat Suite

923.0035.10 418 lbs.

2 - 30"W x 30"H Condos with 12"W Left Hand Litter/Bedroom

**With Platforms:**

Mobile #923.0035.11  
Stationary #923.0035.12



### 4' Wide Cat Suite

923.0039.10 418 lbs.

2 - 30"W x 30"H Condos with 18" W Left Hand Litter/Bedroom

**With Platforms:**

Mobile #923.0039.11  
Stationary #923.0039.12



### 4' Wide Cat Condo

923.0040.10 439 lbs.

4 - 24"W x 30"H Condos

**With Platforms:**

Mobile #923.0040.11  
Stationary #923.0040.12



### 5' Wide Cat Condo

923.0050.11 503 lbs.

4 - 30"W x 30"H Condos

**With Platforms:**

Mobile #923.0050.13  
Stationary #923.0050.15



### 5' Wide Cat Suite

923.0050.10 604 lbs.

4 - 24"W x 30"H Condos with 12"W Centered Litter/Bedroom

**With Platforms:**

Mobile #923.0050.12  
Stationary #923.0050.14

# STANDARD CAT CONDO + SUITE ASSEMBLIES



## 5 1/2' Wide Cat Suite

923.0058.10 503 lbs.

4 - 24"W x 30"H Condos with 18"  
Centered Litter/Bedroom

### With Platforms:

Mobile #923.0058.12 556 lbs.  
Stationary #923.0058.14 547 lbs.



## 6' Wide Cat Condo

923.0060.10 657 lbs.

6 - 24"W x 30"H Condos

### With Platforms:

Mobile #923.0060.13 722 lbs.  
Stationary #923.0060.16 710 lbs.



## 6' Wide Cat Suite

923.0060.11 668 lbs.

4 - 30"W x 30"H Condos  
with 12" Centered Litter/Bedroom

### With Platforms:

Mobile #923.0060.14 734 lbs.  
Stationary #923.0060.17 722 lbs.



## 6' Wide Cat Suite

923.0060.12 769 lbs.

4 - 24"W x 30"H Condos with 12"W  
Left/Right Hand Litter/Bedroom

### With Platforms:

Mobile #923.0060.15 835 lbs.  
Stationary #923.0060.18 823 lbs.



## 6 1/2' Wide Cat Suite

923.0068.11 657 lbs.

4 - 30"W x 30"H Condos with 18"W  
Left/Right Hand Litter/Bedroom

### With Platforms:

Mobile #923.0068.14 722 lbs.  
Stationary #923.0068.17 710 lbs.



## 7' Wide Cat Suite

923.0068.12 789 lbs.

4 - 24"W x 30"H Condos with 18"W  
Left/Right Hand Litter/Bedroom

### With Platforms:

Mobile #923.0068.15 854 lbs.  
Stationary #923.0068.18 842 lbs.





### 7' Wide Cat Suite

923.0070.10 833 lbs.

4 - 30"W x 30"H Condos with 12"  
Left/Right Hand Litter and Bedroom

#### With Platforms:

Mobile #923.0070.11 907 lbs.

Stationary #923.0070.12 895 lbs.



### 7½' Wide Cat Condo

923.0075.10 753 lbs.

6 - 30"W x 30"H Condos

#### With Platforms:

Mobile #923.0075.11 835 lbs.

Stationary #923.0075.12 820 lbs.



### 8' Wide Cat Condo

923.0080.10 875 lbs.

8 - 24"W x 30"H Condos

#### With Platforms:

Mobile #923.0080.11 965 lbs.

Stationary #923.0080.12 947 lbs.



### 8' Wide Cat Suite

923.0080.13 987 lbs.

6 - 24"W x 30"H Condos with Centered  
and Right Hand 12" Litter and Storage

#### With Platforms:

Mobile #923.0080.14 1,077 lbs.

Stationary #923.0080.15 1,059 lbs.

## SPECIALTY CAT HOUSING

### Kat Play-Around™

Part number determined at time of order.

#### Benefits:

Need a bigger place for cats to play? The Kat Play-Around lets cats climb, jump and play with the benefits of being safely enclosed.

The kennel has proven durability, standing up to anything a cat can bring. Yet its color and tempered glass options lets you showcase the frolicking felines, making the unit as good for your facility as it is for the cats.

#### Features:

- Sturdy Stainless Steel or galvanized steel frame with 1"-square welded tubing.
- 16-gauge single pin latch (can be locked).
- Two lower resting lounges and one large upper lookout perch.
- **Specs:** 49"W x 86½"H x 48"D. (Height includes caster base)

Lower Lounges	12"W x 24"D
Lookout Perch	26"W x 12"D



### Kat Play and Sleep

Part number determined at time of order.

#### Benefits:

Create a playful, colorful environment for your feline friends with a large play area attached to four lounging quarters with feeding and sleeping space. Provides exercise without having to move the cats!

#### Features:

- Large center play area has two horizontal lookout shelves (6"W and two side resting benches (6"W).
- Spacious sleeping areas have attached litter/bedroom areas with pass thrus you can open or close from the outside.
- Laminate Kat Play and Sleep is available in variety of standard colors as well as optional Wilson Art® and Formica® colors with an additional charge and longer lead times.
- Total height as shown: 72"H, or 77"H with caster base.
- **Specs:** 4 - 24"W x 30"H condos each with two attached 15"H litter/bedroom areas; 2 - 36"W x 12"H storage areas with doors and 1 - 24"W x 12"H storage area with doors. All areas are 26½"D. Play area is 24"W x 60"H.



## Stainless Steel Cat Suite

Looking for the space of a Laminate Condo Suite in durable Stainless Steel? This Suite is for you. The Double Unit Stainless Steel Cat Suite provides 18.7 square feet of living space, meeting the new industry standards for feline housing! (9.35 square feet for our Single Unit)

902.4830.22 Single Unit, Main space 48"W 200 lbs.  
902.3630.20 Single Unit, Main space 36"W 190 lbs.  
902.0103.24 Double Unit with Mobile Platform 440 lbs.

### Benefits:

Field-tested by felines and their caretakers! We developed this product with leading University thought leaders, reflecting the latest trends in animal housing. Stainless steel construction provides the best surface for disinfection and an incredibly long service life. We've made this our quietest cage, designed to relieve the stress of the occupant, thus leading to a healthier and safer habitat.

### Features:

- Patented Hinge Design: US Patent #7,805,808
- Stainless steel door design features tighter spacing near the latch, which discourages paw entrapment.
- Lockable door latch to prevent escapes.
- Quiet Closing Latch eliminates noise and creates a stress-free environment for patients.
- You can remove integrated compartment divider for cleaning.
- Grip allows you to open or close portals from the outside without opening cage doors or disturbing occupants.
- Interior polymer resting shelf and other components are made of chemical resistant Polyethylene (PE).
- **Specs:** 48"W x 30"H x 28¼"D or 36"W x 30"H x 28¼"D
- **Single Units:** End and Top Panels are not included, but may be purchased separately.
- **Double Unit:** End and Top Panels are included with purchase.



## Quiet-Time Door Cover for Stainless Steel Cat Suite

179.3330.00 1 lb.

### Benefits:

Give felines some privacy with the new Quiet-Time Door Cover. These covers allow a feline a sense of isolation and comfort during boarding, treatment or recovery.

### Features:

- Color-fast blue nylon construction is stain and snag resistant.
- 3" deep pocket fits snugly over the top of door and secured with plastic snaps.
- Clear vinyl window to display client/patient information.
- Machine washable.



# Low-Stress

## SHOR-LINE

Today's pet parents walk through the door with an expectation that their pet will be treated like a member of the family. Just as pediatricians have changed to meet the needs of today's parents, the animal care field is accommodating the need for lower stress, quieter treatment and housing options. That is the inspiration for the Shor-Line Low Stress™ line of products.

### Kat Portal

902.0000.25	Kat Portal	2 lbs.
300.2229.00	Template	22 lbs.

#### Benefits:

Current research has shown that cats benefit from having more space, especially the opportunity to keep the litter area away from their bedroom. Shor-Line has worked with one of the country's premier feline shelter research institutions to make the Kat Portal available.

This ABS portal retrofits\* easily to connect two Shor-Line cages. This creates a secure portal for the cat to slip easily between the two compartments.

#### Features:

- ABS portal creates an 8" -diameter opening with a 1½" space between is 2¼".
- Comes with a PVC spacer that helps maintain the integrity between the cages.
- Aluminum portal template is required if you are doing the work yourself as it will help you cut the whole in the correct place. Only one template is needed.

\* Has not been tested on other cages.



### Privacy Panel

Call for part number

Catering to the different dog personalities that enter veterinary, boarding, and shelter facilities has become increasingly important. The Privacy Panel provides an attractive, reasonably priced solution that allows you to add a hiding barrier to reduce stressful situations.

#### Features:

- Retrofits any 23.5" or wider T-Kennel grill door (will not work on glass).
- Choose from standard PVC colors.
- Easily attaches to the grill panel.
- Specs: 20.375" W x 27.75" H



### Quiet Closing Latch

702.0030.52	Single Door	2 lbs.
702.0030.51	Double Door	2 lbs.

Retrofit most Shor-Line cages with these latches. (available for single or double door cages.)



### Cat Lounging Bench

High sides help felines crouch down and feel safe. 802.0005.00.



### Quiet-Time Cage Door Cover

Welcome solitude for shy pets; easy solution for you



**SEE PAGE 39**



# CAGE FEEDING ACCESSORIES

## Mounting Choices

Shor-Line offers two types of mounting systems—traditional Shor-Line circle brackets and Kennel Gear™ brackets. Both of these systems can attach to Shor-Line housing products. Mounting systems that work with other housing products are listed at the end of this section.

### Kennel Gear™ Plastic Bowl Kits

041.0017.40	Blue	1.5 lbs.
041.0017.41	Red	1.5 lbs.
041.0017.53	Green	1.5 lbs.
041.0017.54	Pink	1.5 lbs.
041.0017.55	Purple	1.5 lbs.
041.0017.74	Slate Blue	1.5 lbs.
041.0017.75	Grey	1.5 lbs.

#### Benefits:

A clean and efficient food and water solution for all size animals. Door mount prevents bowls from being turned over, spilling food or water.

#### Features:

- Kit comes with a durable 20 oz. polypropylene Plastic Bowl and a plastic Kennel Bar Mount.
- Kennel Bar Mount system fits most standard kennels or solid surfaces. Back plate is not used for solid surface mounting.
- Bowl can be easily inserted into the Kennel Bar Mount for a secure feeding solution and easily removed with the flip of a paw-proof lever.
- **Bowls also available without mounting brackets.**



### Kennel Gear™ Stainless Steel Pail Kits

041.0017.44	1 Quart	2 lbs.
041.0017.45	2 Quart	2 lbs.
041.0017.38	4 Quart	2 lbs.
041.0017.46	6 Quart	3 lbs.

#### Features:

- Kit comes with a durable Stainless Steel Pail and a Kennel Bar Mount made from anodized grade aircraft aluminum to prevent corrosion.
- Kennel Bar Mount fits most standard kennels.
- Kennel Bar Mount back plate is not used for solid surface mounting.
- Two 3/4" thumbscrews are provided.
- Pail can be easily inserted into the Kennel Bar Mount for a secure feeding solution and easily removed with the flip of a paw-proof lever.
- Pail handle folds back and locks in place when pail is securely mounted preventing danger to animals.
- All pails are interchangeable with the various Kennel Gear Mounting Systems.
- **Pails also available without mounting brackets.**



### Kennel Gear™ Stainless Steel Bowl Kits

041.0017.33	1 Pint	2 lbs.
041.0017.34	1 Quart	2 lbs.
041.0017.36	2 Quart	2.5 lbs.
041.0017.43	Double 1 Pint	2 lbs.
041.0017.35	Double 1 Quart	2 lbs.
041.0017.37	Double 2 Quart	2.5 lbs.

#### Benefits:

A clean and efficient food and water solution for all size animals. Door mount prevents bowls from being turned over, spilling food and water.

#### Features:

- Kit includes a durable Stainless Steel Bowl and a Kennel Door Mount made from anodized aircraft grade aluminum to prevent corrosion.
- Kennel Door Mount fits most standard kennels.
- Bowl can be easily inserted into the Kennel Door Mount for a secure feeding solution and easily removed with the flip of a paw-proof lever.
- All bowls are interchangeable with the various Kennel Gear Mounting Systems.



041.0 017.35



041.0017.33

### Kennel Gear™ Stainless Steel Bowls

041.0017.12	1 Pint Stainless Steel Bowl	1 lb.
041.0017.23	1 Quart Stainless Steel Bowl	1 lb.
041.0017.14	2 Quart Stainless Steel Bowl	1.5 lbs.
041.0017.13	Double 1 Pint Stainless Steel Bowl	2 lbs.
041.0017.48	Double 1 Quart Stainless Steel Bowl	2 lbs.
041.0017.97	Double 2 Quart Stainless Steel Bowl	2 lbs.

**Benefits:**

A clean and efficient food and water solution for all size animals.

**Features:**

- Manufactured from stainless steel for durability.
- Bowls are designed to be used with the various Kennel Gear Mounting Systems.



041.0017.48



041.0017.12

### Kennel Gear™ Mounting Systems

041.0017.16	Surface Mount, Aluminum	1 lb.
041.0017.17	Kennel/Cage Bar Mount, Aluminum	1 lb.
041.0017.39	Kennel/Cage Bar Mount, Plastic	1 lb.
041.0017.18	Chain Link Fence Mount, Aluminum	1 lb.
041.0017.57	Universal (Grooming) Table Mount	1 lb.

**Features:**

- A variety of mounting options available: door, surface and table.
- Kennel Gear Door Mounts fit most standard kennels.
- Two 3/4" thumbscrews are provided with door mounts.
- Table mount fits up to 3 1/2" thick tables.



### Economy Bowl Mounting Brackets

802.0002.00	1 1/2 Quart Economy Bowl Bracket	1 lb.
802.0003.01	2 Quart Economy Bowl Bracket	1 lb.
802.0003.00	2 1/2 Quart Economy Bowl Bracket	1 lb.
890.0200.01	10 oz. Feline Bowl + Bracket	1 lb.
890.0200.02	12 oz. Feline Bowl + Bracket	1 lb.

**Benefits:**

Shor-Line bowl mounting brackets help prevent bowls from being turned over, spilling food and water.

**Features:**

- Bracket attaches bowls to Shor-Line cage doors and other wire cage doors.
- Bracket is constructed of stainless steel and installs easily.



802.0003.01



890.0200.02



890.0200.02

### Economy Water/Feed Bowl

190.9000.09	1 Pint Stainless Steel Bowl	1 lb.
190.9000.05	1 Quart Stainless Steel Economy Bowl	1 lb.
190.9000.06	2 Quart Stainless Steel Economy Bowl	1 lb.

**Features:**

- Polished stainless steel looks great and easy to clean.
- You can nest bowls for easy storing.
- One- and two-quart bowls are designed for use with Shor-Line circle bowl mounting brackets (Sold separately; see above).



190.9000.09



190.9000.05



190.9000.06

# ANIMAL HANDLING ACCESSORIES

## Animal Stretcher

918.0003.04 7 lbs.

### Benefits:

This is a secure, professional transport aid for injured or sedated patients. Stretcher is 48" long.

### Features:

- Heavy-duty, 30mil woven vinyl material is easy to clean.
- Rigid, 1" diameter tube frame.
- Two - 2" wide adjustable Velcro®, restraint straps.
- **Specs:** 48" L x 21" W.



## Fetch Pole

918.0002.03 3" long 3 lbs.

918.0002.04 4" long 4 lbs.

918.0002.05 5" long 5 lbs.

### Benefits:

Safe handler control for your patients with an attitude problem.

### Features:

- Soft plastic tubing surrounds the noose cable and the end of the pole for animal's safety.
- Two non-slip grips provide secure control for the animal handler.
- Spring-loaded noose release knob at handler's end instantly widens the noose to free the pet.



## Animal Handling Gloves

918.0001.01 8" Gauntlet, Large 2 lbs.

918.0001.05 8" Gauntlet, Medium 6 lbs.

918.0001.02 8" Gauntlet, Small 2 lbs.

918.0001.03 19" Gauntlet, Large 6 lbs.

918.0001.04 19" Gauntlet, Medium 6 lbs.

### Benefits:

These gloves are especially good for handling fractious cats or dogs.

### Features:

- 19" long gauntlets have a split leather shell and 4mm foam.
- Elk hide glove has double thickness of leather on index finger and back of thumb for added protection.
- Overall length for the 19" Gauntlet Gloves is 27".



918.0001.01



918.0001.03

# GROOMING

## GROOMING TABLES

We crafted our grooming tables with premium features that last for decades...and then we gave you the color you asked for just for fun!

### Big Top Grooming Table™ *New!*

903.3220.53	Electric Lift, Plum Perfect	190 lbs.
903.3220.55	Electric Lift, Screamin' Green	190 lbs.
903.3220.57	Electric Lift, Burnt Orange	190 lbs.
903.3220.59	Electric Lift, Electric Pink	190 lbs.
903.3220.61	Electric Lift, Silver Vein	190 lbs.
903.3220.63	Electric Lift, Shor-Line Blue	190 lbs.
903.3220.53	Electric Lift, Plum Perfect	190 lbs.
903.3220.55	Electric Lift, Screamin' Green	190 lbs.
903.3220.57	Electric Lift, Burnt Orange	190 lbs.
903.3220.59	Electric Lift, Electric Pink	190 lbs.
903.3220.61	Electric Lift, Silver Vein	190 lbs.
903.3220.63	Electric Lift, Shor-Line Blue	190 lbs.
903.3220.64	Electric Lift, Shor-Line Blue	190 lbs.
903.3220.65	Hydraulic Lift, Plum Perfect	145 lbs.
903.3220.66	Hydraulic Lift, Screamin' Green	145 lbs.
903.3220.67	Hydraulic Lift, Burnt Orange	145 lbs.
903.3220.68	Hydraulic Lift, Electric Pink	145 lbs.
903.3220.69	Hydraulic Lift, Silver Vein	145 lbs.
903.3220.70	Hydraulic Lift, Shor-Line Blue	145 lbs.

#### Benefits:

Ergonomics were at the forefront when we developed this table. It effortlessly lifts the pet on a secure, coated table. The pivoting grooming arm adjusts to how YOU want to groom the pet. It's so durable that it will be your grooming partner for years!

**Shor-Line tables are designed for animal use only.**

#### Features:

- Pivoting grooming arm travels 180° around the end of the table. The arm locks into five positions horizontally, any position between 22" and 39" vertically and the loop hook has six position choices.
- Proprietary polyurethane coated table top provides a secure and comfortable surface for the pet. Plus, it's very durable and easy to clean.
- Smooth and quiet lifting system can be operated from both sides of the table.
- Other features include: leveling legs; powder coated heavy gauge steel construction; actuator lifts up to 200 lbs. from 20" to 41" high and new, super-sized 48" L x 26" W table top.
- The ONLY CSA/UL certified grooming table.



#### Colors Available:



### Kennel Gear™ Sport Caddy

041.0017.56	Red with Table Mount	2 lbs.
041.0017.61	Blue with Plastic Bar Mount	2 lbs.
041.0017.62	Blue with Table Mount	2 lbs.
041.0017.66	Black with Table Mount	2 lbs.

#### Benefits:

This single-opening supply caddy increases your productivity.

#### Features:

- Constructed of durable polypropylene.
- Provides a convenient, accessible place for you to place supplies, tools and other items.
- Also available in black.



### Kennel Gear™ Professional Grooming Caddy

041.0017.30 7 lbs.

#### Benefits:

The Professional Grooming Caddy helps extend the life of your tools, keeps you organized and increases your productivity.

#### Features:

- The Professional Grooming Caddy comes with a Universal Table Mount that fits up to 3½" wide tables.
- Two large inner bays hold spray bottles or the Wahl Clipper Comb Tray, outer bays for combs, clippers, files and a specially designed graduated scissors slot.



## Elite Grooming Table

903.3220.36	Hydraulic Lift, Plum Perfect	137 lbs.
903.3220.37	Hydraulic Lift, Screamin' Green	137 lbs.
903.3220.38	Hydraulic Lift, Burnt Orange	137 lbs.
903.3220.39	Hydraulic Lift, Electric Pink	137 lbs.
903.3220.11	Hydraulic Lift, Silver Vein	137 lbs.
903.3220.44	Hydraulic Lift, Shor-Line Blue	137 lbs.
903.3220.19	Electric Lift, Plum Perfect	187 lbs.
903.3220.20	Electric Lift, Screamin' Green	187 lbs.
903.3220.21	Electric Lift, Burnt Orange	187 lbs.
903.3220.22	Electric Lift, Electric Pink	187 lbs.
903.3220.10	Electric Lift, Silver Vein	187 lbs.
903.3220.42	Electric Lift, Shor-Line Blue	187 lbs.

### Benefits:

Ergonomics were at the forefront when we developed this table. It effortlessly lifts the pet on a secure, coated table. The pivoting grooming arm adjusts to how YOU want to groom the pet. It's so durable that it will be your grooming partner for years!

**Shor-Line tables are designed for animal use only.**

### Features:

- The ONLY CSA/UL certified grooming table on the market.
- Pivoting grooming arm travels 180° around the end of the table.
- The arm locks into five positions horizontally, any position between 22" and 39" vertically. The loop hook has six position choices. All features allow the groomer to operate the table efficiently and comfortably.
- Proprietary polyurethane coated table top provides a secure and comfortable surface for the pet. Plus, it's durable and easy to clean.
- You can operate our smooth and quiet lifting system from both sides of the table.
- Bright color lasts because of the powder coated, heavy-gauge steel construction.
- The actuator lifts up to 200 lbs. from 20" to 41" high.
- **Specs:** Super-sized 26"W x 42.44"L table top.



903.3220.20

### Colors Available:



# ANATOMY OF A: GROOMING TABLE

Proprietary polyurethane coated table top helps prevent slipping

Check out the tube size! Extra durable

Foot pedal works from both sides

Arm made of 1", 11-gauge Stainless Steel \*

Grooming Arm included five locking positions pivots 180 degrees

Support bracket attaches to the frame for added strength and durability

Class A color powder coating, best quality available!

\*Only CSA/UL listed grooming table!\*

## GROOMING TUBS

### Small Animal Bathing Tub

904.0752.30 367 lbs.

#### Benefits:

The perfect tub for your smaller animals! The Small Animal Bathing Tub has ergonomics in mind with bathing height of 29" after you set the pet over the 36" lip onto the stainless steel grill. The supply caddy keeps everything you need within reach.

Need the tub higher? Sturdy tubular legs can adjust the height and then anchor the tub with triangular stainless steel flat feet flush against a wall or corner. The high backsplash keeps the water in the tub.

#### Features:

- This sturdy tub will last for decades. It's fabricated from 18-gauge stainless steel and strengthened with a tubular frame.
- Adjust the height of the stainless steel tubular legs with new stainless steel triangular feet that feature two mounting holes to secure the tub to the floor.
- The triangular feet allow you to mount the tub directly against the wall or corner.
- The grill sits 4" off the tub floor.
- Backsplash is 30"W x 27"H from the bottom of the tub. Left and right side splashes are 24"L x 27"H.
- Stainless steel Tie-Down Ring mounted on backsplash.
- Mounting holes centered on the backsplash and side splashes on 4" centers for optional plumbing fixture with sprayer handle and Supply Caddy.
- **Includes:** Stainless steel Supply Caddy, 4" tall stainless steel grill floor, plastic Hair Strainer Insert and plugs for mounting holes not in use.
- **Specs:** 52"H x 30"W x 24"L. Tub is 11" deep and the lip of the tub is 36" (counter-height) from the floor.
- Plumbing fixtures not included.



### Classic Grooming Tub

904.0702.35 Left Hand Drain 367 lbs.

904.0702.34 Right Hand Drain 367 lbs.

#### Benefits:

This basic grooming tub fills up with features. Durability is standard with a sturdy tube frame construction strengthening the one-piece backsplash. Adjustable feet make it sturdy whether it is free-standing or placed against a wall.

#### Features:

- Constructed with radiused corners along all the corners of the tub (the ONLY one on the market to do so!)
- 45° angles on the front edges add safety and aesthetic appeal.
- Move the included PVC Coated Tub Floors onto the rails to raise the grooming platform and help reduce strain on your back.
- Sliding restraint ring design allows you to turn dogs around without detaching the safety lead.
- Use the Supply Caddy or remove it, using the two provided plugs.
- **Includes:** Supply Caddy, 2 PVC Coated Tub Floor Panels, plastic Hair Strainer Insert and Restraint Rings.
- **Specs:** 60"H x 55¼"W x 24"D
- Plumbing fixtures not included.



## Elite Grooming Shower

904.0702.32	Right Hand Drain	367 lbs.
904.0702.33	Left Hand Drain	367 lbs.

### Benefits:

Bathing animals is easier with the new Elite Grooming Shower. This shower's sturdy tube frame construction—one piece-backsplash and adjustable feet—make it sturdy whether it's free-standing or placed against a wall.

### Features:

- Constructed with radiused corners along all the corners of the shower (the ONLY one on the market to do so!).
- 45° angles on the front edges add safety and aesthetic appeal.
- Sliding restraint ring design allows you to turn dogs around without detaching the safety lead.
- Use the Supply Caddy or remove it, using the two provided plugs.
- **Includes:** Supply Caddy, 2 PVC Coated Floor Panels, plastic Hair Strainer Insert and Restraint Rings.
- **Specs:** 56"W x 50½"H x 24½"D.
- Plumbing fixtures not included.



## Elite Grooming Tub

904.0702.40	Left Hand Door, Right Hand Drain	367 lbs.
904.0702.41	Right Hand Door, Left Hand Drain	367 lbs.

### Benefits:

Washing animals gets a little easier with the new Elite Grooming Tub. This tub's durable construction features the same 1"-square tube frame as our cages. The frame adds strength to the one piece-backsplash, and adjustable feet let you place on most any surface. The tub stays stable whether it's free-standing in a room or placed against a wall.

### Features:

- Constructed with radiused corners along all the corners of the tub. (The ONLY on the market to do so!)
- 45° angles on the front edges add an element of safety and aesthetic appeal.
- Sturdy
- Steps slide in and slide out with the touch of your foot, allowing you to keep your hands free and not bend down.
- Slip resistant tread on steps.
- PVC Coated Tub Floors have the option of a floor panel set upon the rails to raise the showering platform to an ergonomic showering level.
- Door is completely removable and features the hinges that are used on our cages.
- Door latch is easy to use and constructed of the same long lasting material as our hinges.
- Sliding restraint ring design allows dogs to be turned around in the tub without detaching the safety lead.
- Removable Supply Caddy comes with 2 plugs to close unused mounting holes.
- Includes: Supply Caddy, 2 PVC Coated Tub Floor Panels, Hair Trap Drain Insert and Restraint Ring.
- Plumbing fixtures are not included and may be purchased separately.
- **Specs: 55.25"W x 60"H x 24"D**

\* Our most popular grooming tub!



## GROOMING ACCESSORIES

### PVC Coated Tub Floors

317.0098.57	30" L Grill Floor Piece, Solid	15 lbs.
317.0098.58	30" L Grill Floor Piece, with Notch	15 lbs.

#### Benefits:

Our tub floors provide sure footing for pets while bathing or dipping. The notched floor piece features easy drain access.

#### Features:

- Designed to be used in our Elite Grooming Shower or Tub and Classic Grooming Tub. Use two pieces per tub or shower— one solid and one with a notch.
- Floor is coated with approximately 1/8" thick non-toxic PVC coating, which is approved for animal use.
- Sturdy frame and 3 3/4" legs with a heavy-gauge perforated sheet steel.
- Openings are approximately 3/8" diameter after PVC coating.



### Wall Mount Faucet, Stainless Steel Hose

804.0006.10 Stainless Steel Hose 12 lbs.

#### Features:

- 12" swing-away nozzle and self-closing spray head.
- Flexible, 8" stainless steel hose extends for easy cleaning of those hard to reach areas.
- Wall mount hanger hook holds hose and spray head when not in use.



### Wall Mount Faucet, Coil Hose

804.0006.72 Coil Hose 8 lbs.

#### Features:

- Lightweight spray head provides less fatigue when bathing pets.
- Flexible hose extends for easy cleaning of those hard to reach areas.
- Wall mount hanger hook holds hose and spray head when not in use.



### Sink Drain Kit with Strainer Basket

804.0008.25 1 lb.

#### Features:

- 3 1/2" in diameter.
- Recessed sink drain kit for tub tables.
- Comes with strainer basket.



### Hair Interceptor

704.0702.6 8 lbs.

#### Features:

- Removeable plastic filtering system.
- Intercept the fur before it clogs your plumbing!





### Spill Resistant Vacuum Breaker

804.0015.00 2 lbs.

#### Benefits:

Designed to prevent contamination of potable water due to back-siphonage. Required for any municipality governed by USC regulations for faucets with continuous pressure spray hoses.

#### Features:

- Now lead free!
- In-line flow design with integral shut-off valves.
- Approved under ASSE 1056, CSA and USC FCCC and HR.



### Backflow Preventer and 3/8" Vacuum Breaker

804.0006.56 8 oz.

#### Features:

- 3/8" diameter IPS male inlet and female outlet.
- Double check design prevents back flow.
- 2 3/8" length from top to bottom.
- Comes standard with 804.0006.72.
- This is a replacement part.

### Anti-Fatigue Mat

803.0100.07 36" x 24" 5 lbs.

803.0100.05 48" x 24" 6 lbs.

803.0100.06 48" x 36" 7 lbs.

#### Benefits:

Prevent leg and back discomfort while standing during long strenuous hours of grooming.

#### Features:

- Dual-density, closed-cell foam distributes your weight without feeling "unstable."
- Mats are 1/2" thick with tapered and rolled edge.
- Embossed pebble surface, black color. You can clean easily with soap and water.



### Stat-Mats™ Anti-Fatigue Mat

803.0206.00 19"W x 38"L x 2"H 8 lbs.

803.0207.00 28"W x 38"L x 2"H 10 lbs.

#### Benefits:

Extra thick anti-fatigue mat to help minimize leg and back discomfort common among groomers.

#### Features:

- Constructed of dual-density, closed-cell foam and a proprietary polyurethane coating. Provides a durable, long lasting, supple surface that does not break down.
- Gives your muscles a break as they adjust to the flexibility of the mat, promoting circulation.
- Mats are 2" thick.
- Seamless coating means no bacteria buildup and easy cleaning.
- Waterproof and stain-resistant surface.



# DRYER CAGES

## Dryer Cages

926.4836.01	Single Unit	129 lbs.
926.2000.02	Double Unit	258 lbs.
926.3000.03	Triple Unit	205 lbs.

US Patent #6,058,886

### Benefits:

Patented heat-free drying method eliminates burns and dehydration while providing a speedy drying time.

### Features:

- Designed with two high volume fans placed on opposite ends of the assembly. These fans act to create turbulence, which lifts and dries the pet's coat while removing the loose undercoat.
- Fan guards at both ends protect paws from fan blades, and multi-speed settings let you determine how fast the airflow dries patients.
- All fans are UL listed and feature OSHA compliant guards.
- Rounded corners throughout prevent bacterial buildup, making a healthier environment for animals and staff.
- Fluid-retaining lip prevents urine or other leakage.
- Removable PVC coated floors included.
- Wide doors mean easier animal entrance and exit.
- Can also be equipped with stacking plastic cages for holding areas—leaving you free to dry the next animal.
- Includes a removable cage divider gives you the option of drying two smaller animals at one time.
- Double unit includes a mobile double large dryer cage on the bottom with another double large dryer cage on the top.
- Locking caster base provides instant portability.
- **Specs:** Single Unit is 48" x 36". Double Unit is two 48" x 36" cages stacked. Triple Unit is one 48" x 36" cage with two smaller holding cages stacked above. Each cage compartment is a one-piece mold of high-density polyethylene with a  $\frac{3}{16}$ " thick wall. 25½"H x 44¼"W x 28"D. Maximum total air volume is 3,560 CFM. Requires 120V AC, 1.4 AMPS per fan.



926.2000.02



926.4836.01



926.3000.03

# TABLES

## EXAM TABLES

Your exam tables tell a lot about your practice.

Set the table for positive client interactions with clean elegance.

There is a Shor-Line table to meet every need. Whether you are building a new business or updating an existing facility, a Shor-Line exam table is the symbol of quality and beauty. See how practicality meets sophistication in our product line.

### Blue-Line Rotational Lift Table (RLT)

Patent #8,333,159; D706,426

903.3330.00	RLT, Standard Blue	892 lbs.
903.3330.01	RLT, Jade	892 lbs.
903.3330.02	RLT, Taupe Gray	892 lbs.
903.3330.03	RLT, Black	892 lbs.
903.3331.00	RLT with Scale, Standard Blue	905 lbs.
903.3331.01	RLT with Scale, Jade	905 lbs.
903.3331.02	RLT with Scale, Taupe Gray	905 lbs.
903.3331.03	RLT with Scale, Black	905 lbs.

#### Benefits:

The Rotational Lift Table (RLT) is the hardest working table you never knew you couldn't live without. While the table does the work, you converse with your customers. The table gives the pet a quick ride, saves your back and your customer is impressed.

You will never stop finding new ways to get more out of this table. And, it will last for decades.

**Shor-Line tables are designed for animal use only.**

#### Lifts them up

- Starts at 9½" (approx. length of the average female foot).
- Maximum lift height is 47¾".
- Powerful actuator can lift up to 200 lbs.
- Ultra-quiet lift takes pet to counter height (36") in about 20 seconds.

#### Peninsula Mode engages pet parents

- With only 22½" between you and your customer, you are partnering on caring for the pet.
- The length (44½") gives you good animal control.

#### Lateral Mode creates extra safety and control

- Pet is only 22½" from backboard.
- Tiedown rails on both sides to secure patient, if needed.
- For nervous or aggressive patients, the backboard provides secure positioning for pet and vet.
- Clears the area when treating giant breeds on floor.

#### Easy adjustability and functionality

- Quickly adjusts from lateral to peninsula between patients, locking in place.
- Safety is built in with descending motion stopping when it encounters an obstacle.
- Blue-Line table top has radius corners and laminated polyurethane edging that can hold up to a liter of fluid.

#### Comes fully equipped

- Two wireless remote controllers.
- One wireless foot control.
- Manual up/down switch.
- On/Off key switch to lock unit.

#### Features:

- Actuator: 120V, 15 amps. (available in 240V)
- Stainless Steel table top.
- Table size: 44½" L x 22½" W x 1" H
- Maximum footprint: 44" W x 82½" H x 56" D
- Base mounting: Heavy-duty, low-profile base mounting plate minimizes obstructions under table.
- Wall mounting: Mounts to any concrete surface of 4" or greater or any 2" x 4" reinforced wooden stud wall with 16" or 24" stud centers.
- Power outlet: Located in rear of unit.
- Available with K9-W8 scale. See scale section for features.

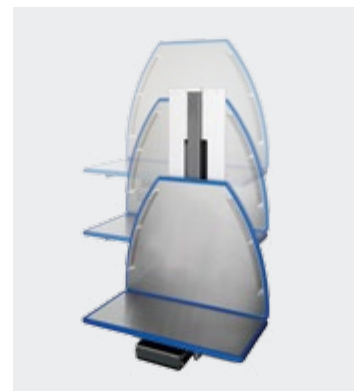

### BLUE-LINE COLORS



## LIFT TABLES

### Get a Lift

A lift table shifts the wear and tear of repeated lifting from you and your staff to a machine. Go mobile or pick a stationary lift table.

### CoJack® Multi-Purpose Table

903.3130.00 281 lbs.

#### Benefits:

All your patient lifting, exam, transport and surgical procedures in one table. Another of the Shor-Line Back-Saving products, the CoJack® Multi-Purpose Table offers more than just years of service. It offers the budget conscious the opportunity to own a sturdy table that can lift, tilt and transport without the clutter of numerous tables that serve just one function.

**Shor-Line tables are designed for animal use only.**

#### Features:

- 60" L x 22" W stainless steel table top with raised edge to channel fluids to drain opening.
- Top raises from 14" to 40" with a 60° tilt capability.
- Four sliding tie-down restraints.
- Four corrosion resistant, 360° swivel and total locking casters with non-marring polyurethane wheels.
- Lift/Tilt rocker switch selection is activated by a foot pedal.
- Rechargeable 24-volt actuator system lifts up to 250 lbs.



### Lift Exam Table

916.1140.02 Table 248 lbs.  
916.3400.02 Table with Scale 285 lbs.

#### Benefits:

Focus on the pet and let your foot operate the lift. The gentle start and stop helps keep everyone calm.

**Shor-Line tables are designed for animal use only.**

#### Features:

- Lifts patients up to 200 lbs.
- Exam surface travels from 12" to 39" high.
- Backboard has two restraint bars with adjustable, locking cam cleats for patient restraint.
- Features an Aggressive Behavior Position: The lateral exam table lets you securely position the animal against the backboard and use the tie-down fixtures if you need to restrain a fractious patient.
- **Specs:** Exam surface is 44½" L by 20" W
- **Available with K9-W8 scale. See scale section for features.**



916.3400.02



## Mobile Animal Lift Table

903.3120.00 Table 187 lbs.  
903.3120.02 Table with Scale 278 lbs.

### Benefits:

The multi-functional Mobile Animal Lift Table solves your lifting, exam and treatment issues, especially for injured and Post-Op patients.

**Shor-Line tables are designed for animal use only.**

### Features:

- Foot switch engages a quiet, battery-operated rechargeable actuator system that lifts up to 200 lbs.
- Table top raises from 10 $\frac{3}{4}$ " to 37 $\frac{3}{4}$ " high.
- Stainless steel exam top is 44 $\frac{1}{2}$ "L by 20"W with raised edges to prevent fluid run-off.
- Mobile Animal Lift table features two tie-down restraint cleats on each side of the table that can be used to restrain a fractious patient.
- Corrosion resistant reinforced nylon locking casters and rotating non-marring bumpers.
- Available with K9-W8 scale. See scale section for features..



Mounted Scale Readout Option

903.3120.02

## Economy Lift Exam Table

903.1240.02 Hydraulic 187 lbs.  
903.1240.00 Electric, 120V 206 lbs.

### Benefits:

A great lift exam table for the budget conscious.

**Shor-Line tables are designed for animal use only.**

### Features:

- "Super-sized" stainless steel exam top, 46" x 25".
- Lifts up to 250 lbs.
- Table top raises from 20" to 41" high.
- Electric version available in 240V as well.

Hydraulic option



903.1240.00

## Fear Free Table

### Benefits:

This new stationary exam table takes the next step in giving the pet a gentle, calming exam experience. The dog can choose to walk up secure, fold down stairs to a warm exam top with a comfy towel.

**Shor-Line tables are designed for animal use only.**

### Features:

- Developed in conjunction with Dr. Marty Becker and Fear Free(sm), which aims to provide a relaxing environment to encourage calmer, more accepting patients.
- Heated Stainless Steel exam top provides a warm surface that has safety shutoffs.
- Non-slip stairs (four steps) fold down and gently settle on the floor with rubber feet, decreasing noise. It operates with fingertip ease, allowing you to focus on the pet.
- 4 $\frac{1}{2}$ "W clips at either end of the table let you attach a washable towel in a soothing color.
- Toe kicks (3") around the sides and front of table allow you to comfortably be closer to the table.
- The Fear Free badge indicates this table is part of a Fear Free practice.
- Specs: 27"W x 40"L x 36"H.



Coming Soon! Beta model shown at NAVC

**FEAR FREE  
RECOMMENDED**

## FOLD-UP WALL MOUNT TABLES

**Feel the difference.** Our Fold-Up Wall Mount tables are the ONLY table on the market with radiused corners. Feel the machine-formed corners and see how our skilled team creates a lip to help prevent runoff.

### Blue-Line Fold-Up Wall Mount Exam Table

903.1530.04	Lateral, Standard Blue	102 lbs.
903.1530.05	Lateral, Jade	102 lbs.
903.1530.06	Lateral, Taupe Gray	102 lbs.
903.1530.07	Lateral, Black	102 lbs.
903.1531.04	Peninsula, Standard Blue	99 lbs.
903.1531.05	Peninsula, Jade	99 lbs.
903.1531.06	Peninsula, Taupe Gray	99 lbs.
903.1531.07	Peninsula, Black	99 lbs.

#### Benefits:

Blue-Line Wall Mounts provide a creative splash of color to a sturdy, stainless steel table filled with versatile features. The Blue-Line Fold-Up Wall Mount Table offers extra stability and elegance while maximizing valuable floor space with the industry approved Shor-Line wall mount design.

**Shor-Line tables are designed for animal use only.**

#### Features:

- The ONLY Fold-Up Wall Mount with radiused corners.
- Laminated polyurethane edging holds up to one liter of fluid.
- Torsion spring technology allows you to easily and safely raise and lower the table.
- Wall Mount allows you to set the height to your ergonomically correct working height.
- Weight capacity: 200 lbs. when installed based on manufacturer's recommendations.
- Table mounting template included.
- **Specs:** Table Top is 44½" L x 22½" W x 1" H. Five inches from the wall when folded up. Easy to mount to any standard 2" x 4" reinforced wooden stud wall with 16" or 24" stud centers.
- Also compatible with our Stainless Steel Utility Chase.
- Cabinet mounting option and Specialized Cabinetry available.



### Fold-Up Wall Mount Exam Table

903.1130.04	Peninsula	91 lbs.
-------------	-----------	---------

#### Benefits:

Maximize valuable space with our Fold-Up Wall Mount Table featuring an attractive laminated underside. Torsion Spring Technology allows you to easily and safely raise and lower the table.

**Shor-Line tables are designed for animal use only.**

#### Features:

- The ONLY folding table on the market with radiused corners.
- **Specs:** 20 gauge stainless steel exam table is 44" L x 22" W with raised edge to prevent fluid run off.
- 200 lbs. capacity.
- Adjustable top allows for exact leveling of the work platform.
- Optional laminate top available.
- Easily Mounts to Utility Chase. page 65.
- Cabinet mounting option and Specialized Cabinetry available.



# STATIONARY TABLES

Stationary Wall Mounts offer a clean, attractive stainless steel exam table for positive customer interaction.

## Blue-Line Stationary Wall Mount Exam Table

903.1030.01	Standard Blue	97 lbs.
903.1030.02	Jade	97 lbs.
903.1030.03	Taupe Gray	97 lbs.
903.1030.04	Black	97 lbs.

### Benefits:

Simplicity at its best. This Blue-Line table injects a sophisticated splash of color to a sturdy, stainless steel table. Add visual appeal and ample exam surface space to your facility with this Blue-Line table option. The wall mount design leaves floor space open. Consider adding an optional storage drawer to help keep your exam area clutter free.

**Shor-Line tables are designed for animal use only.**

### Features:

- Stainless Steel Blue-Line Table Top is 44½" L x 22½" W x 1" H.
- Blue-Line Table Top with radius corners and laminated polyurethane edging holds up to one liter of fluid.
- Storage drawer is 11" W x 15½" L x 4¼" H.



## Stationary Wall Mount Exam Table

903.1030.00 77 lbs.

### Benefits:

Large exam surface with storage drawer. Wall mount design leaves floor space open.

**Shor-Line tables are designed for animal use only.**

### Features:

- Extra-large stainless steel exam surface, 46" L x 22" W.
- Storage drawer is 11" W x 15½" L x 4¼" H.



## Mark II and IV Exam Tables

903.1000.10	Mark II, White	251 lbs.
903.1000.50	Mark II, Almond	251 lbs.
905.6210.10	Mark IV with Scale, White	298 lbs.
905.6210.50	Mark IV with Scale, Almond	298 lbs.

### Benefits:

The ultimate exam table combines durable stainless steel surface with the option of reliable Shor-Line scale and plenty of storage underneath.

**Shor-Line tables are designed for animal use only.**

### Features:

- Stainless steel exam top with scale makes good use of space.
- Chip-resistant, 3mm PVC edging on door and drawer edges
- Cabinet is high pressure laminate. Comes standard in white or almond. Other Wilson Art or Formica colors are available with additional cost and longer lead times.
- **Specs:** Exam top is 44½" L x 22½" W.
- **Available with scale. See scale section.**



## PEDESTAL TABLES

### Blue-Line Pedestal Base Exam Table

903.1110.01	Standard Blue	170 lbs.
903.1110.02	Jade	170 lbs.
903.1110.03	Taupe Gray	170 lbs.
903.1110.04	Black	170 lbs.

#### Benefits:

This quality stainless steel exam table takes a step up in class with the addition of the Blue-Line Table Top.

**Shor-Line tables are designed for animal use only.**

#### Features:

- Blue-Line Table Top with radiused corners and laminated polyurethane edging holds up to one liter of fluid.
- Heavy, tip-resistant base has adjustable leveling feet.
- **Specs:** Table Top is 44½" L x 22½" W x 1" H. Overall height is 35".



### Pedestal Base Exam Table

903.1110.00 170 lbs.

#### Benefits:

Quality stainless steel exam table at a budget price.

**Shor-Line tables are designed for animal use only.**

#### Features:

- Heavy, tip-resistant base has adjustable leveling feet.
- Table top has a raised edge to prevent fluid run-off.
- **Specs:** 44½" L x 20" W exam surface. Overall height is 35".



## BLUE-LINE COLOR OPTIONS

Blue



Jade



Taupe Gray



Black





# UTILITY CHASES

## Stainless Steel Utility Chase

907.0000.00 367 lbs.

### Benefits:

The Shor-Line Stainless Steel Utility Chase is truly the backbone of a multi-functional treatment and procedure area, offering custom design, durability and ease of cleaning. This product is completely modular providing you a blank canvas to design your work space to suit your individual needs.

**Shor-Line tables are designed for animal use only.**

### Features:

- The chase stretches from floor to ceiling to surround and cover electrical, plumbing and oxygen lines.
- Three of the four panels are designed to accept optional equipment including: Exam/Procedure Lights, Otoscope/Ophthalmoscope Sets, Anesthesia Units, etc.
- Many shelf and cabinet options are also available for instrument and supply storage.
- A large selection of Shor-Line tubs and exam tables can be attached to the chase, but the panels can also serve as a "docking station" for our line of mobile exam and treatment tables.
- Laminate is also available. Standard laminate colors are white and almond. Optional Wilson Art® or Formica® colors are available at additional cost and longer lead time.
- Plumbing fixtures and other cabinets and tables may be purchased separately.



Shown with optional tub tables, fold up wall mount table and shelf (shown above left tub table).

Only Chase included.

# CORNER GUARDS/KICK PLATES

## Corner Guards

937.0000.02	Adhesive Tape Attachment, 48"	5lbs.
937.0000.03	Adhesive Tape Attachment, 72"	5lbs.
937.0000.07	Adhesive Tape Attachment, Custom Size	5lbs.
937.0000.00	Screw Attachment, 48"	5lbs.
937.0000.01	Screw Attachment, 72"	5lbs.
937.0000.06	Screw Attachment, Custom Size	5lbs.

### Benefits:

Protect your hallways with easy-to-install 18-gauge stainless steel corner guards. Available in custom sizes.

## Kick Plates

937.0000.05	Adhesive Tape Attachment, 12" x 32"	5lbs.
937.0000.09	Adhesive Tape Attachment, Custom Size	5lbs.
937.0000.04	Screw Attachment, 12" x 32"	5lbs.
937.0000.08	Screw Attachment, Custom Size	5lbs.

### Benefits:

Your doors say a lot about your facility. Keep them looking good with 18-gauge stainless steel door plates. Available in custom sizes.



## EXAM + TREATMENT TABLES

Give your exam room a signature look with laminate or stainless cabinets with knee space for better animal positioning options.

### Exam and Treatment Tables with Knee Space

#### Benefits:

High quality cabinetry that stands the test of time gives you storage flexibility. Our most popular plan is a single door with three drawers. Choose between a 46" top for tight spaces or modest floor plans, or the longer 60" top for more space.

**Shor-Line tables are designed for animal use only.**

#### Features:

- Both 46" and 60" exam/treatment tables are 36" high.
- Exam top is 46" L x 25" W or 60" L x 25" W.
- Three storage options: six drawer, door and three drawers or two doors.
- Standard cabinet colors are available in stainless steel, white or almond.
- Optional Wilson Art® or Formica® colors are available at additional cost and longer lead time.
- Optional pull-out shelf available for models with doors.
- Additional configurations available. Please speak with your sales representative to learn more.

\*Color it up!

Chose between dozens of Wilson Art® or Formica® colors to set your own style. See our color with your imagination page on [shor-line.com](http://shor-line.com).

### Left Hand Tables



#### 46" Long Table, White

903.1405.11 289 lbs.

One door and three drawers with left hand knee space and laminate top.



#### 46" Long Table, Almond

903.1405.51 289 lbs.

One door and three drawers with left hand knee space and laminate top.



#### 60" Long Table, Stainless Steel

903.5000.03 424 lbs.

One door and three drawers with left hand knee space and stainless steel top.

### Right Hand Tables



#### 60" Long Table, White

903.1401.10 290 lbs.

Two doors with right hand knee space and laminate top.



#### 60" Long Table, Almond

903.1404.50 290 lbs.

Six drawers with right hand knee space and laminate top.



#### 60" Long Table, White

903.1105.10 290 lbs.

One door and three drawers with right hand knee space and stainless steel top.

\* Don't see what you like? Choose your own on the next page.

# HOW TO BUY TUB TABLES + EXAM/TREATMENT TABLES

## SIZE

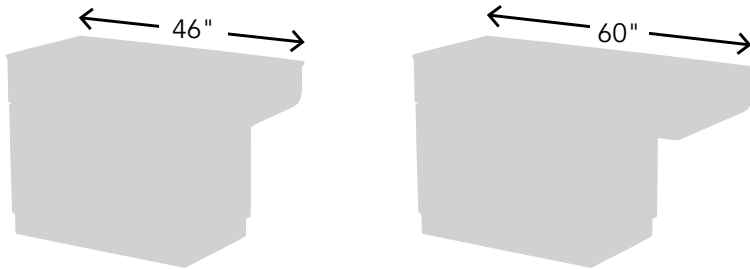

46" Long



60" Long

All Exam Tops are 25"W x 36" H.

All Tub Tables are 24 5/8" W x 36" H.

24-5/8" Wide Tub Table Top

## KNEE SPACE



Right Side



Left Side

\* Knee Space determines which side of the table storage will be built.

## CABINET CONFIGURATION

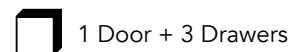
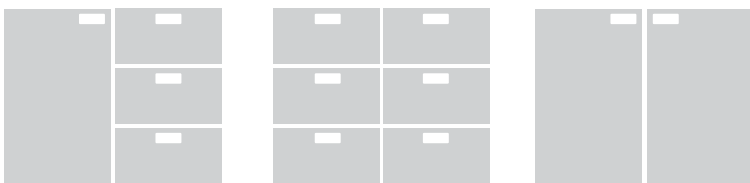

1 Door + 3 Drawers



6 Drawers\*



2 Doors

\* Not available for Tub Tables.

## TABLE TOP MATERIAL

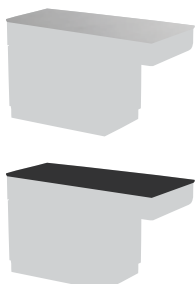

Stainless Steel

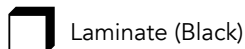

Laminate (Black)

## CABINETSRY MATERIAL

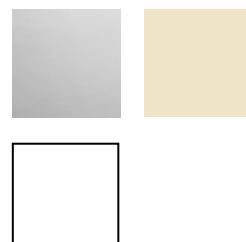

Stainless Steel

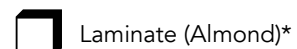

Laminate (Almond)\*

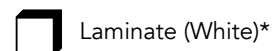

Laminate (White)\*

\* Additional Wilson Art® or Formica® laminate colors available at additional cost and longer lead time.

# TUB TABLES

## Tub Tables with Knee Space

### Benefits:

Shor-Line's multi-purpose tub tables add efficiency and user comfort to many of your daily procedures. Cabinets provide ample instrument storage for dental services, necropsy and surgical procedures.

**Shor-Line tables are designed for animal use only.**

### Features:

- Two storage options: door and three drawers or two doors.
- Standard cabinet colors are white or almond. Optional Wilson Art® or Formica® colors are available at additional cost and longer lead time.
- Both 46" and 60" tub tables are 36" high.
- Two piece grill top included.
- Plumbing fixtures may be purchased separately.
- Optional pull-out shelf available for models with doors.
- Additional configurations available. See "How to Buy" on previous page.



#### 46" Long Tub Table, White

904.4100.10 288 lbs.

One door and three drawers with right hand knee space and stainless steel tub.



#### 46" Long Tub Table, White

904.4100.10 288 lbs.

One door and three drawers with left hand knee space and stainless steel tub.



#### 46" Long Tub Table, Almond

904.1100.50 268 lbs.

Two doors with left hand knee space and stainless steel tub.



#### 60" Long Tub Table, White

904.4000.11 338 lbs.

One door and three drawers with right hand knee space and stainless steel tub.



#### 60" Long Tub Table, Almond

904.4000.51 347 lbs.

One door and three drawers with right hand knee space and stainless steel tub.



#### 60" Long Tub Table, Stainless Steel

904.5000.01 416 lbs.

One door and three drawers with right hand knee space and stainless steel tub.

\* Don't see what you like? Choose your own on page 67.



## Tub Tables

904.2100.10	46" Long, 6" Deep Tub, White	353 lbs.
904.2100.50	46" Long, 6" Deep Tub, Almond	353 lbs.
904.2101.10	46" Long, 16" Deep Tub, White	353 lbs.
904.2101.50	46" Long, 16" Deep Tub, Almond	353 lbs.
904.2000.10	60" Long, 6" Deep Tub, White	353 lbs.
904.2000.50	60" Long, 6" Deep Tub, Almond	353 lbs.
904.2001.10	60" Long, 16" Deep Tub, White	353 lbs.
904.2001.50	60" Long, 16" Deep Tub, Almond	353 lbs.

### Benefits:

Shor-Line's multi-purpose tub tables add efficiency and user comfort to many of your daily procedures. Cabinets provide ample instrument storage for dental services, necropsy and surgical procedures.

**Shor-Line tables are designed for animal use only.**

### Features:

- Cabinets are constructed of ¾" MRB (moisture resistant board).
- All door edges are wrapped with 3 mm PVC to prevent chipping and for additional moisture protection.
- Standard cabinet colors are white or almond. Optional Wilson Art® or Formica® colors are available at additional cost and longer lead time.
- All tub tables are 24⅞"W and 36"H.
- The stainless steel grill covers are recessed.
- Plumbing fixtures may be purchased separately.



904.2100.10

## Stainless Steel Exam Top for Tub Tables

804.3104.03	46" Long Exam Top	13 lbs.
804.3004.03	60" Long Exam Top	15 lbs.

**Shor-Line tables are designed for animal use only.**

### Features:

- Heavy gauge, austenitic stainless steel.
- 60" tub top measures 24⅞" x 47⅙".
- 46" tub top measures 24⅞" x 33⅙".



804.3004.03  
Cabinet not included.

## Bi-Level Tub Table

990.0400.00	165 lbs.
-------------	----------

### Benefits:

Our Bi-Level Tub is truly multi-purpose. Bathe small and large pets or use for dental and other procedures. You can even use this tub to wash cage and table accessories while using the upper level as a drain board.

**Shor-Line tables are designed for animal use only.**

### Features:

- Manufactured with seamless weld construction from 14-gauge austenitic stainless steel. Measures 25"W X 36"H.
- The tub is sturdily supported by four stainless steel tubular legs that feature fully enclosed gussets and adjustable feet.
- The sloping portion of the tub tapers from 4¾" to 5¾" before dropping to an 18" depth.
- The inner dimensions measure 21⅙"W x 54"L, and the outer dimensions are 25"W x 60½"L.
- The height from the floor to the tub top is 36", and 18" from the floor to the bottom of the tub.
- All holes for the faucet and drains are pre-drilled. Drain is 3½" diameter.
- Removable stainless steel grill is included.
- Plumbing fixtures may be purchased separately.



Plumbing shown  
sold separately.

### Economy Tub Tables

904.3100.00	46" Long Mini, 6" Deep Tub	150 lbs.
904.3101.00	46" Long Mini, 16" Deep Tub	160 lbs.
904.3000.00	60" Long Standard, 6" Deep Tub	145 lbs.
904.3001.00	60" Long Standard, 16" Deep Tub	168 lbs.

**Benefits:**

You can use this tub/table anywhere in your facility. Because it's 100% stainless steel, it's perfect for any area with high humidity or wet floors. Stainless steel two-piece grill is included.

**Shor-Line tables are designed for animal use only.**

**Features:**

- All Tubs are 24½"W and 36"H.
- Both models are supported on a stainless steel frame, constructed of 1¼" square tubing.
- 2 piece stainless steel grill included.
- Plumbing fixtures may be purchased separately.



904.3000.00

### Economy Deck Mount Faucets

804.0006.64	8' Heavy Duty Polyethylene Hose	8 lbs.
804.0006.51	8' Stainless Steel Hose	11 lbs.

**Benefits:**

Lightweight aluminum spray head provides less fatigue when bathing.

**Features:**

- Wide-radius gooseneck nozzle with aerator and automatic diverter directs water stream where it's needed most.
- Large 4" long faucet handles allow activation with wrist or forearm, model 804.0006.51 only).
- Stainless steel spray head available.



804.0006.51



804.0006.64

### Elite Scrub Sink Options *New + improved!*

904.0200.03	Elite Scrub Sink (Sink only)	75 lbs.
990.0400.173	Elite Scrub Sink with Foot Pedal	125 lbs.
990.0400.172	Elite Scrub Sink with Knee Valve	100 lbs.
990.0400.50	Elite Scrub Sink with Infrared Sensor	100 lbs.

**Benefits:**

Our newly improved Elite Scrub Sink has designer touches that provide additional wall protection. It is perfect for pre-surgical scrub-up and is an essential part of daily cleaning chores. Its heavy duty stainless steel construction provides strength for day to day abuse.

**Features:**

- Elite Scrub Sink comes with sink only.
- All packages include Scrub Sink, Rigid Gooseneck Faucet and drain unit with removable stainless steel basket.
- **Specs:** 21"W x 33"L with a 10"D bowl depth and a 21½" D.



990.0400.50



990.0400.173



990.0400.172

# SURGERY TABLES

## Quality craftsmanship for the surgery suite

You've trained for years to become a skilled surgeon, so you deserve our best craftsmanship as your work surface.

\* Premium value surgery table!

## CONTINUUM SURGERY TABLES

**Who says value can't be premium?** We packed our Continuum Surgery Tables with high-quality features. Manual jack lifts the patient while the table tilts to the perfect surgery angle.

### Continuum V-Top Surgery Table *New + improved!*

903.4100.01 Hydraulic Base 280 lbs.  
903.4800.01 Short V-Top 277 lbs.

#### Benefits:

You can position the patient from horizontal to near-vertical without external devices. The new Flip Open Trough™ design provides ergonomic ease of use and ready access to trough cleaning. Gives the dependable operation you expect from Shor-Line. Lifts up to 250 lbs.

**Shor-Line tables are designed for animal use only.**

#### Features:

- Two polymer five lobe ergonomic knobs open the tops to 270° for easy access to remove surgical waste. Just clean the trough and reinsert the tray for the next surgical procedure.
- Tiedown attachment on each side.
- A 3" stainless steel trough permits fluid runoff into a drain outlet.
- Continuum Surgery table base is a distinctive stainless steel hemmed column with a clean and sophisticated design.
- The round, tubular "X" base is designed with enough clearance for feet and other surgical tools that need to be in close proximity of the table.
- The base is powder-coated gun metal grey and will stand up to cleaning and disinfecting agents.
- The Hydraulic Jack allows you to place the table anywhere you want with no cords.
- The hydraulic mechanism lifts the table from 30½" to 41".
- Short V-Top has same features as longer version with 46" length.
- **Specs:** Top 19"W x 58"L. Short V-Top is 19"W x 46"L.
- **Need it taller?** Optional height extenders available. (3" higher 803.4000.09; 6" higher 803.4000.07)



### Continuum Flat-Top Surgery Table *New + improved!*

903.4000.04 Hydraulic Base 280 lbs.

#### Benefits:

Shor-Line crafts a durable and elegant table from one piece of stainless steel with radiused curves to remove the possibility of sharp edges. This keeps this table seam-free, which helps promote a bacteria free environment.

**Shor-Line tables are designed for animal use only.**

#### Features:

- Durable stainless steel top stands up to decades of surgery.
- Attachment rail system runs continually along the sides and ends of the table.
- Four sliding, quick-release, cam cleat tie-down attachments come with the table, allowing you to tighten them in any position along the rail.
- Continuum Surgery table base is a distinctive stainless steel hemmed column with a clean and sophisticated design.
- The round, tubular "X" base is designed with enough clearance for feet and other surgical tools that need to be in close proximity of the table.
- The base is powder-coated gun metal grey and will stand up to cleaning and disinfecting agents.
- The Hydraulic Jack allows you to place the table anywhere you want with no cords.
- Table can be lifted from 30½" to 41" via hydraulic mechanism.
- **Specs:** Extra large 22"W x 60"L flat top.
- **Need it taller?** Optional height extenders available. (3" higher 803.4000.09; 6" higher 803.4000.07)



## CLASSIC SURGERY TABLES

### Let our legacy help create yours

Today's Shor-Line owners just completed their latest upgrade to the Classic Surgery Table their grandfather originally created some 60 years ago. We've improved this favorite continuously based on veterinarian input. New this year:

- Even more adjustable lift column to accommodate different surgeon heights.
- Improved sturdy tilt that locks in place in multiple positions.
- Enclosed hydraulic jack with virtually NO maintenance needed.
- Ergonomically improved V-Top handles.

Veterinary surgery has changed a lot since the 1950s, and the Classic has changed with it. What has not changed is Shor-Line's commitment to quality.

### Classic Flat-Top Surgery Table *New + improved!*

903.4000.01 Hydraulic Base 280 lbs.

#### Benefits:

Premium stainless steel is crafted with smooth, radiused curves to a graceful but functional, seamless table that promotes a bacteria-free environment.

**Shor-Line tables are designed for animal use only.**

#### Features:

- Directional tilt lock secures the top in almost any position, from horizontal to near vertical.
- Extra large 22"W x 60"L stainless steel flat top.
- Raised center permits fluid run-off into a perimeter trough and to a drain outlet.
- Top rotates 360° (hydraulic base only).
- Attachment rail system runs continually along the sides and ends of the table.
- Four sliding, quick-release, cam cleat tie-down attachments come with the table, allowing you to tighten them in any position along the rail.
- Hydraulic mechanism lifts table from 28¾" to 39¾".
- **Need it taller?** Optional height extenders available. (3" higher 803.4000.09; 6" higher 803.4000.07)



### Classic V-Top Surgery Table, Hydraulic *New + improved!*

903.4100.02 Hydraulic Base 280 lbs.

903.4800.00 Short V-Top 227 lbs.

#### Benefits:

The V-Top acts as a helper during surgery, keeping the patient in the correct position. Check out the extra features in this premium table. Gives you flexibility to go from straight horizontal and level to V-Shaped, near vertical positioning without external devices. You choose how you want to operate.

**Shor-Line tables are designed for animal use only.**

#### Features:

- High-quality, durable stainless steel table surfaces.
- Two polymer five lobe ergonomic knobs open the tops to 270° for easy access to remove surgical waste. Just clean the trough and reinsert the tray for the next surgical procedure.
- Two-panel system that adjusts from horizontal to near vertical to hold the patient in the desired position during surgery.
- Two sliding, quick-release, cam cleat tie-down attachments provided on each side of the attachment rail.
- 3" stainless steel trough permits fluid runoff into a drain outlet.
- Table can be lifted from 30½" to 41" via hydraulic mechanism.
- Top can rotate 360 degrees or be stationary
- Solid stainless steel base that lasts for decades.
- Short V-Top Has Same Features as longer table but with 46" Length.
- **Specs:** Overall size of the top is 19"W x 58"L.
- **Need it taller?** Optional height extenders available. (3" higher 803.4000.09; 6" higher 803.4000.07)
- Also available in electric.

*\* Industry standard table!*



*\* Also available in 46"  
-Same great features  
(also in Continuum)*



## Feline Surgery Table *New + improved!*

903.4000.05 227 lbs.

### Benefits:

The size and needs of feline patients drove the design of this surgery table. Its shorter, more compact size still has the quality and durability you need. The table has a raised edge to help prevent fluid runoff. A drain hole allows fluid to drain off the table, away from the patient.

**Shor-Line tables are designed for animal use only.**

### Features:

- Stainless Steel Top features a drain outlet.
- Directional tilt lock secures the top in almost any position, from horizontal to near vertical.
- Top rotates 360° (hydraulic only).
- Attachment rail system runs along the sides of the table.
- Four sliding, quick-release, cam cleat tie-down attachments are provided, and can be tightened in any position along the rail.
- Table can be lifted from 28¾" to 39¾" via hydraulic mechanism.
- **Specs:** 20"W x 44½"L top.



## A DURABLE CLASSIC THAT LASTS THROUGH GENERATIONS

"My father was Dr. Louis Leonpacher, immigrant veterinarian educated in Germany. He was building a new clinic which was to be air conditioned! This was circa 1948. I began using the table in 1962 after graduation from Texas A&M. When I went to the University of Florida for a residency in Lab Animals, I sold it to Dr. Dave Elston. Later when his son-in-law opened a practice, he gave it to Dr. Carson. When the veterinarians in the Lafayette, Louisiana area were starting an emergency clinic the table was transferred to the clinic. I filled in at that emergency clinic for a few months in 2000, where I recognized the table."

- Robert J. Leonpacher, DVM



## HEATED SURGERY TABLES

### Continuum Heated V-Top Surgery Table *New*

903.4402.00 Hydraulic Base, Heated, 120V 290 lbs.

#### Benefits:

Our Heated Continuum V-Top has the same great features as our Continuum V-Top with the addition of a heating panel to help prevent hypothermia during small animal surgeries.

#### Features:

- Each panel has an 8¼" x 44" heated area. Overall heated area is 16½" x 44".
- The thermostatic control mounted on the frame has a timer for 60, 90 and 120 minutes.
- There is a built-in alarm and shut-off to alert you to an overheating situation.
- Factory-set temperature is maintained at 95°F (35°C) with even heat distribution. (The temperature is NOT adjustable.)
- **Need it taller?** Optional height extenders available. (3" higher 803.4000.09; 6" higher 803.4000.07)



Thermostatic control

### Continuum Heated Flat-Top Surgery Table *New*

903.4202.00 Hydraulic Base, Heated, 120V 290 lbs.

#### Benefits:

Our Heated Continuum Flat-Top has the same great features as our Continuum Flat-Top with the addition of a heating panel to help prevent hypothermia during small animal surgeries.

#### Features:

- 15" x 46" heated area.
- The thermostatic control mounted on the frame has a timer for 60, 90 and 120 minutes.
- There is a built-in alarm and shut-off to alert you to an overheating situation.
- Factory-set temperature is maintained at 95°F (35°C) with even heat distribution. (The temperature is NOT adjustable.)
- **Need it taller?** Optional height extenders available. (3" higher 803.4000.09; 6" higher 803.4000.07)



Thermostatic control

### Classic Heated V-Top Surgery Table, Hydraulic *New + improved!*

903.4400.01 Hydraulic Base, Heated, Rotational, 120V 290 lbs.

903.4410.01 Hydraulic Base, Heated, Non-Rotational, 120V 290 lbs.

#### Benefits:

Our Heated Classic V-Top has the same great features as our Classic V-Top with the addition of dual heating panels to help prevent hypothermia during small animal surgeries.

#### Features:

- Each panel has an 8¼" x 44" heated area. Overall heated area is 16½" x 44".
- The thermostatic control mounted on the frame has a timer for 60, 90 and 120 minutes.
- There is a built-in alarm and shut-off to alert you to an overheating situation.
- Factory-set temperature is maintained at 95°F (35°C) with even heat distribution. (The temperature is NOT adjustable.)
- **Need it taller?** Optional height extenders available. (3" higher 803.4000.09; 6" higher 803.4000.07)



Thermostatic control

### Classic Heated Flat-Top Surgery Table *New + improved!*

903.4200.01 Hydraulic Base, Heated, Rotational, 120V 290 lbs.

903.4210.01 Hydraulic Base, Heated, Non-Rotational, 120V 290 lbs.

#### Benefits:

Our Heated Classic Flat-Top has the same great features as our Classic Flat-Top with the addition of a heating panel to help prevent hypothermia during small animal surgeries.

#### Features:

- 15" x 46" heated area.
- The thermostatic control mounted on the frame has a timer for 60, 90 and 120 minutes.
- There is a built-in alarm and shut-off to alert you to an overheating situation.
- Factory-set temperature is maintained at 95°F (35°C) with even heat distribution. (The temperature is NOT adjustable.)
- **Need it taller?** Optional height extenders available. (3" higher 803.4000.09; 6" higher 803.4000.07)



Thermostatic control

**Shor-Line tables are designed for animal use only.**

# PREP + UTILITY TABLES

**Dependable Utility Tables.** Shor-Line's collection of utility tables feature durable stainless steel and a range of shapes and sizes to meet your needs.

## Mobile Instrument Table

903.2003.00 86 lbs.

### Benefits:

Keep your instruments within reach with this stand that slides easily over all standard small animal surgery tables.

**Shor-Line tables are designed for animal use only.**

### Features:

- Table measures a full 33" between legs.
- Handle adjusts tabletop height from 40" to 53"
- 4" casters provide infinite maneuverability and are equipped with locking brakes.
- **Specs:** Work surface 23"W to 40"L.



## Mayo Stand

803.0010.00 19 lbs.

### Benefits:

Compact size, but large enough for most surgical procedures.

**Shor-Line tables are designed for animal use only.**

### Features:

- Easy-slide extension posts allow height adjustments from 34" to 53"H.
- Ergonomically designed handles make adjustments simple.
- Legs and base are constructed of 1", chrome-plated steel tubing.
- Black hard rubber casters allow for easy transport.
- **Specs:** Removable stainless steel tray measures 12½"W x 19"L x ¾"D.



## Mobile Instrument Stand

803.0010.01 17 lbs.

### Benefits:

Compact size, but large enough for most surgical procedures.

**Shor-Line tables are designed for animal use only.**

### Features:

- Chrome plated stand adjusts from 30" to 50" high.
- Ergonomically designed handles make adjustments simple.
- Base consists of five 22½"-diameter epoxy coated steel legs.
- Five heavy-duty casters allow for easy maneuverability.
- **Specs:** Removable stainless steel tray measures 12½"W x 19"L x ¾"D.



### Mobile Prep Table

903.1120.04 90 lbs.

**Benefits:**

Economical yet durable, this cart can take critical patients from the waiting room to exam to surgery. Works equally well moving equipment and supplies.

**Shor-Line tables are designed for animal use only.**

**Features:**

- Durable, stainless steel construction.
- Lower shelf for more storage area.
- 34" height provides a convenient match-up to most tables in your facility.
- 5" locking casters, corrosion proof.
- **Specs:** 20"W x 44½"L prep surface.



### Blue-Line Mobile Prep Table

903.1120.10	Standard Blue	91 lbs.
903.1120.12	Jade	91 lbs.
903.1120.13	Taupe Gray	91 lbs.
903.1120.11	Black	91 lbs.

**Shor-Line tables are designed for animal use only.**

**Features:**

- Durable Stainless Steel construction that's built to last.
- Two levels for storage
- 34" height provides a convenient match-up to most tables.
- 5" locking corrosion proof casters provide mobility.
- **Specs:** Table Top is 44½"L x 22½"W x 1"H.



### Utility Table

903.2004.00 25 lbs.

**Benefits:**

The stainless steel, protected top comfortably holds up to 50 pounds. It's perfect for any hospital needing an easy-to-clean table for procedures.

**Shor-Line tables are designed for animal use only.**

**Features:**

- Provides a larger surface area than similar tables and standard Mayo Stands.
- The table top height is adjustable from 26¾" to 43¾" high.
- Locking casters makes it easy to move wherever it is needed!
- **Specs:** 11¾"W x 23¾"L.



### Mobile Utility Cart

903.2320.31 32 lbs.

**Benefits:**

This table provides easy access to equipment and instruments.

**Shor-Line tables are designed for animal use only.**

**Features:**

- 200 lb. weight capacity.
- Cart features three shelves that are electronically welded to the legs with an underside padding to dampen vibration and noise.
- Shelf size: 18"D x 27"L with a 12¼"H shelf clearance.
- Durable stainless steel construction. Protective bumpers on legs and handles safeguard doors, walls and furnishings.
- **Specs:** 30¾"L x 33"H x 18¾"D.



## TABLE ACCESSORIES



803.0202.00

### Stat-Mats™ Prep/Exam Pad

803.0200.00	20"W x 44"L x 1"H	8 lb.
803.0202.00	20"W x 30"L x 1"H	6 lb.
803.0201.00	20"W x 44"L x ½"H	8 lb.

#### Benefits:

Provides conductive warmth and cushioned comfort for animals during short or long procedures.

#### Features:

- A beneficial and cost effective solution that boldly addresses the concern of heat loss in the veterinary clinic or animal hospital.
- Constructed from high-quality insulating materials, Stat-Mats™ prevent body heat loss that occurs from contact with cold surfaces.
- Closed cell foam and polyurethane coating provide a durable, long lasting, supple surface that does not break down and is moisture and abrasion resistant.
- Seamless coating means no bacteria build-up and easy cleaning.
- Waterproof and stain resistant.
- Saves cost of laundering towels.

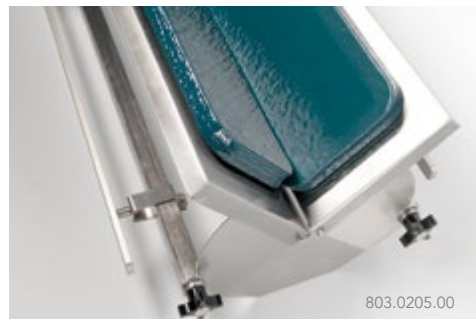

803.0205.00

### Stat-Mats™ Surgery Table Pad

803.0203.00	15"W x 50"L x 1"H	7 lb.
803.0204.00	15"W x 40"L x 1"H	6 lb.
803.0205.00	V-Top; 2-Piece	5 lb.

#### Benefits:

Provides conductive warmth and cushioned comfort for animals during short or long procedures.

#### Features:

- A beneficial and cost effective solution that boldly addresses the concern of heat loss in the veterinary clinic or animal hospital.
- Constructed from high-quality insulating materials, Stat-Mats™ prevent body heat loss that occurs from contact with cold surfaces.
- Closed cell foam and polyurethane coating provide a durable, long lasting, supple surface that does not break down and is moisture and abrasion resistant.
- Seamless coating means no bacteria build-up and easy cleaning.
- Waterproof and stain resistant.
- Saves cost of laundering towels.



### Blue-Line Non-Skid Mat

197.0008.00 5 lbs.

#### Benefits:

The Blue-Line Table Top Non-Skid Mat provides solid footing while providing a more comfortable table surface for the patient.

#### Features:

- Mat fits Blue-Line table tops & scale tops (44½"L x 22½"W x 1"H).
- ¼" thick with tapered edge.
- Dual-density, closed-cell foam that distributes weight to prevent the patient from feeling "unstable."
- Embossed pebble surface, black in color.
- Easily cleaned with soap and water.



### Classic Surgery Table Caddy

803.0002.02 5 lbs.

#### Benefits:

Provides mobility for hydraulic base Shor-Line Classic Surgery Table for assistance with cleaning purposes.

#### Features:

- Easy to install.
- Lift table slightly opposite the wheels and push table.
- Leveling legs keep base from sliding.
- For Classic Surgery Table only.



914.0002.00

**Vacu-Positioner Kit**

914.0002.00	Vacu-Positioner Kit	6 lbs.
814.0002.01	19½" x 39¼" Pad Only	2 lbs.
814.0002.02	11¾" x 23½" Pad Only	2 lbs.

**Benefits:**

The vacuum property of the pad holds your patients in position for x-ray and surgery while minimizing heat loss—without sandbags, adhesive tape or bolsters.

**Features:**

- Safe and durable, it's made of an extremely strong plastic material that is compatible with most commonly used disinfectants.
- Radioluscent.
- Kit comes complete with two Vacu-Positioner pads, 30" long air hose and a vacuum pump.



**Collection Pails**

904.9001.01	Pail with Caster Base	9 lbs.
190.9000.04	Pail only	6 lbs.

**Benefits:**

Superior to plastic for cleaning and sanitation. Caster Base makes it virtually un-tipable. Kick it around the O.R. where needed!

**Features:**

- 12½ quart 100% seamless stainless steel pail.
- Pail nests into a frame made from ½" thick x 1" high stainless steel band.
- Four 2" hard rubber casters allow the pail/frame to be easily moved.
- Outer frame is wrapped with a heavy duty conductive rubber bumper that offers protection to other equipment and the pail itself.



**Thoracic Positioner**

803.0003.00 5 lbs.

**Benefits:**

Holds your patients in the desired position allowing you to operate efficiently.

**Features:**

- Sure-grip rubber feet hold the thoracic positioner in place on a flat-top surgery table.



**Surgeon's Chair**

918.0004.33 23 lbs.

**Benefits:**

Comfortable economy seat for surgery with arm rests for tedious procedures.

**Features:**

- Pneumatic seat adjusts from 18½" to 26½".
- Padded upright swivels from backrest to forearm support.
- Adjustable foot ring.
- Comes in black.



**Economy Lab Stool**

918.0004.34 17 lbs.

**Benefits:**

Comfortable seating for lab or exam room.

**Features:**

- Pneumatic seat adjusts from 19½" to 27½".
- Comes in black.

# LIGHTING

Our Prelude LED Surgery lights have been making a positive impact in surgery suites around the country. These high-quality, affordable surgery lights have the flexibility veterinarians love with the UL/CSA certification that provides piece of mind.

We took the extra step to certify the surgery lights because we understood the reviewers would in many cases hold us to the human surgery standard and potential state electrical requirements.

We are pleased to announce that this year the Prelude series will expand to include LED Exam Lights. They will spend the first part of the year in extensive testing in veterinary facilities before launching to the broader market towards Fall 2017.

## COMING SOON

### Prelude LED Exam Lights

Single Ceiling Mount 60 lbs.  
Single Wall Mount 36 lbs.  
Single Ceiling Mount 116 lbs.

#### Benefits:

Form meets function with the attractive LED exam light. Its curved arm positions easily with fingertip control to give you a closer look at potential problem areas. The cool light keeps the doctor and patient comfortable even with protracted exams.

#### Features:

- Light uses 11 white LED lights with individual parabolic reflectors with a burn life of up to 75,000 hours, which is about 30 years of service if operating 8 hours a day, six days a week.
- Stylish curved arm features drift-free placement in multiple positions.
- Switch on the back of the light adjusts to high or low light viewing.
- Light head swivels easily for ideal illumination.
- High efficiency of LED lights reduces energy use by 20% over other bulbs.
- Auto voltage sensing of 120V-240V.
- Product has a 3-year warranty.



Halogen Dual Ceiling Mount



Single Ceiling Mount

Mobile

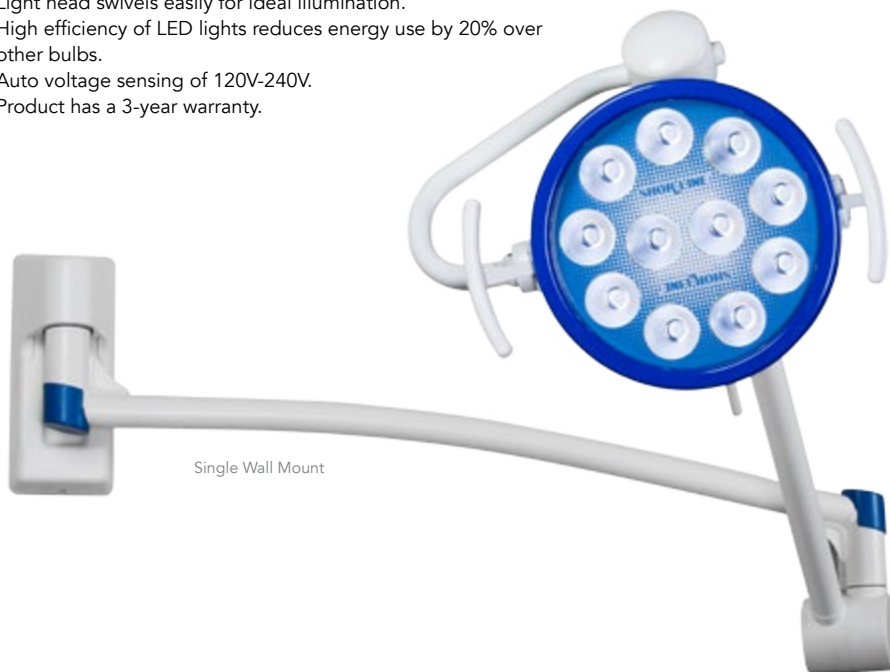

Single Wall Mount

## LED LIGHTS

### Prelude Series LED Surgery Lights

913.8000.04	Single Ceiling Mount	65 lbs.
913.8000.05	Dual Ceiling Mount	109 lbs.
913.8000.06	Single Wall Mount	41 lbs.
913.8000.07	Mobile	122 lbs.

#### Benefits:

The lights feature a color temperature of 4500 K for visual tissue clarity and at one meter working distance featuring a 6 inch (152 mm) field of illumination, so you don't need to refocus and reposition the lights. This lessens eye strain. The lights use 18 white light LEDs with individual parabolic reflectors with a burn life of 75,000 hours.

The lights are cool to the touch and comfortable to work under. A dimming switch allows for illumination adjustment up to 100,000 LUX maximum. The lights' convenient memory feature remembers the LUX of the last use time.

#### Features:

- High efficiency. In general LEDs consume only 20% of the power other bulbs require.
- Very low heat - cool to work under
- No replacement bulbs or fuses necessary.
- Easily positioned and drift free.
- Low maintenance.
- Product has a 3-year warranty.
- Two removable, autoclavable handles are included.
- Auto voltage sensing of 120V-240V.
- CSA/UL certified.



913.8000.04



913.8000.06



913.8000.07



913.8000.05



# HALOGEN LIGHTS

## Surgical Dome Light

913.5005.01	Single Ceiling Mount	86 lbs.
913.5005.02	Dual Ceiling Mount	136 lbs.
913.5005.03	Single Wall Mount	70 lbs.
913.5005.04	Mobile	125 lbs.

### Benefits:

Surgical Dome Lights feature an excellent field of illumination with proper intensity and correct color. Power supply technology replaces hot, heavy transformers and increases bulb life. Many swivel options with non-drift positioning.

### Features:

- The single 15" reflector provides a shadow-free beam at 4000° Kelvin.
- Bulb produces a 6" diameter field of harmonious light and 43,000 LUX at a normal 36" working distance.
- The best articulating arm delivery system for mobile, wall and ceiling applications.
- Autoclavable handles.



913.5005.02



913.5005.03



913.5005.01



913.5005.04

## Surgical Spot Light

913.5006.01	Single Ceiling Mount	86 lbs.
913.5006.03	Wall Mount	39 lbs.
913.5006.04	Mobile	125 lbs.
913.5007.01	Spot/Dome Ceiling Mount	136 lbs.

### Benefits:

Surgical Spot Lights feature an excellent field of illumination with proper intensity and correct color. Power supply technology replaces hot, heavy transformers and increases bulb life. Many swivel options with non-drift positioning.

### Features:

- Continuously adjustable spot from 3" to 11" diameter at 4000° Kelvin.
- Produces 44,000 LUX footcandles at a normal 36" working distance.
- Lamp head and arm both rotate 360 degrees on a horizontal plane.
- The best articulating arm delivery system for mobile, wall and ceiling applications.
- Autoclavable handles.



913.5007.01



913.5006.03



913.5006.01



913.5006.04

# ANESTHESIA

**Trusted Performance.** Our anesthesia line features products designed for veterinarians with needs of pets at the forefront.

**Considering an anesthesia machine?**

As a veterinarian, you double as the surgeon and anesthesiologist for cherished fur children. You need innovative products that put safety first and are intuitive to operate.



## THE DIFFERENCE IN ANESTHESIA VALVES

There have been important advances in anesthesia valves. On Shor-Line anesthesia equipment, we offer you the added safety of a Safety Pressure Relief Valve.

The Safety Pressure Relief Valve is designed to help avoid most pop-off valve closure-related accidents because the operator must continually push down to close the valve. This extra feature can help avoid anesthesia-related complications from overinflating the animal's lungs because the operator can't accidentally leave the valve shut.



# HOW TO BUY ANESTHESIA

## WHAT TYPE OF UNIT DO YOU WANT?



- Anesthesia Machine + Oxygen Concentrator  
You might consider the Pureline M6000, which is a complete unit with everything but the vaporizer and back-up oxygen.
- Anesthesia Machine  
We offer choices for wall mount, table top and mobile.

## MOUNT

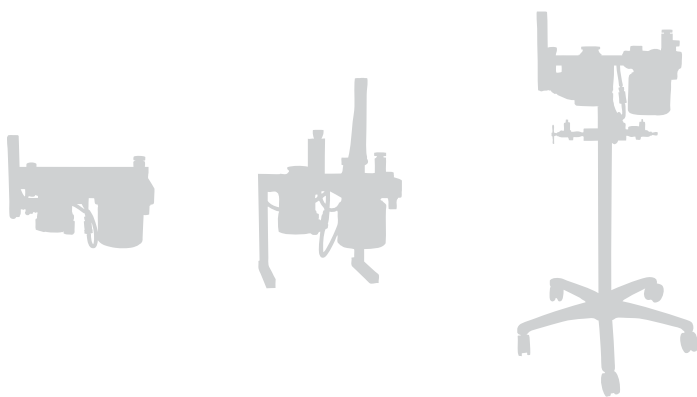

- Wall Mount  
If you have O<sub>2</sub> connections on the wall, this could be your best choice. We offer both flush mount and mounted with articulating arm.
  - Standard
  - Articulated
- Table Top  
This gives you flexibility to move to different stations but you will need space to place the unit. (This is most often used in laboratories.)
- Mobile  
There are several choices, depending on how you want to provide your oxygen.

## OXYGEN

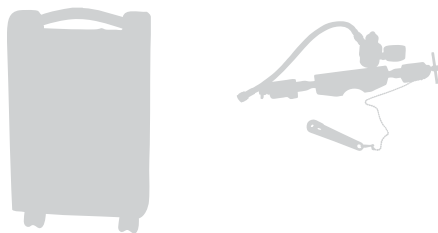

- Oxygen Concentrator
- E-Tank Manifold  
(Note: Shor-Line does not sell oxygen)
- Utilize Piped in Hospital O<sub>2</sub>  
(All Shor-Line units accept piped in O<sub>2</sub>.)

## VAPORIZER

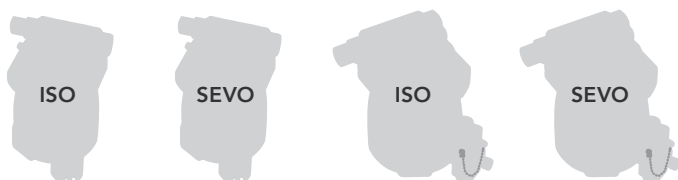

- Isoflurane, Pour or Key Fill
- Sevoflurane, Pour or Key Fill

# ANESTHESIA MACHINES

## Pureline M6000 Anesthesia Machine

195.1142.00 45 lbs.

### Benefits:

Built specifically for veterinary use, Pureline M6000 Anesthesia Machine with O<sub>2</sub> Concentrator is FDA approved, UL listed and backed by a full 10-year warranty on the anesthesia machine and a 3-year warranty on the O<sub>2</sub> concentrator.

### Features:

- Includes patented pressure relief valve to ensure pet safety.
- 0-4 l/pm precision flow meter.
- Audible and illuminated safety alerts.
- Easy on/off controls are large and easily accessible.
- Quiet 40-dBA operation.
- Valves are simple, durable and maintenance-free.
- Heavy-duty shelf holds all monitor types safely and securely.
- Same features as OC6000 (page 86).
- Uses standard "E" Tank for backup and oxygen flush.
- Adult, pediatric and non-rebreathing circuits included.
- Heavy-duty rebreathing bags included.
- Sturdy chassis and low center of gravity for extreme stability.
- Made in the USA with state-of-the-art manufacturing.
- Vaporizer sold separately. See page 88.



Vaporizer not included.

## \* Best option!

All the best features are combined—an O<sub>2</sub> concentrator to save money and deluxe anesthesia machine on a sturdy cart.

## Wall Mount Anesthesia Units

195.1040.01 Safety Pressure Relief Valve 40 lbs.

195.1056.01 Safety Pressure Relief Valve with Articulating Arm 45 lbs.

### Benefits:

Conveniently located on the wall, this design is best suited for work stations in radiology or dentistry.

Units with the Articulating Arm extend 24" from wall with full 180° movement and feature high-quality metal bearings for smooth operation.

### Features:

- Mounts on standard 16" centers.
- Adult & pediatric unilimb rebreathing circuits.
- Non-rebreathing system with 1-liter bag.
- 0-4 Lpm O<sub>2</sub> flow meter with mechanical stop flow control.
- Comes with 0.5-, 1-, 2- and 3-liter bags.
- Industry best 10-year warranty.
- Vaporizer sold separately. See page 88.



195.1040.01  
Vaporizer not included.



195.1056.01  
Vaporizer not included.

## Table Top Anesthesia Units

195.1042.01 Safety Pressure Relief Valve 18 lbs.

### Benefits:

These rebreathing anesthesia machines provide flexibility to move to table top, wet table or mount to a cart.

### Features:

- Compact 13" x 13" footprint.
- Includes adult and pediatric unilimb rebreathing circuits.
- 0-4 Lpm O<sub>2</sub> flow meter with mechanical stop flow control.
- Non-rebreathing system with 1-liter bag.
- Comes with 0.5-, 1-, 2- and 3-liter bags.
- Industry best 10-year warranty.
- Vaporizer sold separately. See page 88.



195.1042.01  
Vaporizer not included.



## Basic Mobile Anesthesia Machine

195.1178.00 Basic Mobile Anesthesia Machine

35 lbs.

### Features:

- Five leg base with shielded casters.
- CO2 absorber with pressure gauge.
- "One seal" canister with lifetime warranty against breakage.
- Dual O2 supply ready with check valves.
- 0-4 lpm oxygen flowmeter with mechanical stop.
- Oxygen flush with 30 lpm safety restrictor.
- Common gas outlet for non-rebreathing systems.
- Safety pressure relief valve included.
- Syringe holder for inflating E/T cuffs.
- Adult & pediatric unilimb rebreathing circuits.
- Non-rebreathing system with 1 liter bag.
- 0.5, 1, 2 and 3 liter bags.
- Ten-year warranty on parts.
- Vaporizer, Dual "E" Tank Manifold and bottles sold separately.



Vaporizer not included

## Premier and Plus Mobile Anesthesia Units

195.1179.00 Plus 70 lbs.

195.1180.00 Premier 70 lbs.

### Features:

- "One seal" canister with lifetime warranty against breakage.
- Sturdy A-frame cart with 18" square footprint.
- Plus model has durable, one-level shelf. Premier model has larger shelf with back bar that contains an organizer for supplies.
- CO2 absorber with pressure gauge.
- Dual O2 supply ready with check valves.
- 0-4 lpm oxygen flowmeter with mechanical stop.
- Oxygen flush with 30 lpm safety restrictor.
- Common gas outlet for non-rebreathing systems.
- Safety pressure relief valve included.
- Syringe holder for inflating E/T cuffs.
- Adult & pediatric unilimb rebreathing circuits.
- Non-rebreathing system with 1 liter bag.
- 0.5, 1, 2 and 3 liter bags.
- Ten-year warranty on parts.
- Vaporizer, Dual "E" Tank Manifold and bottles sold separately.



Premier

Plus

Vaporizer not included



Organizer included on back of Premier unit.

# OXYGEN CONCENTRATORS

Make free oxygen from room air!

## Basic Pureline OC4000 Oxygen Concentrator

195.1150.00 38 lbs.

### Benefits:

Our Basic Oxygen Concentrator rolls independently to work with your existing wall, table top or mobile unit. It allows you to get your oxygen for free by converting room air to medical-grade oxygen. This machine is built for veterinary use and is FDA-approved and UL tested.

### Features:

- Energy efficient and costs average of 12 cents a day to operate.
- Includes 10 feet of high-pressure O<sub>2</sub> hose with female DISS end fittings.
- 5 liter per minute.
- Lightweight (38 lbs.).
- **Size:** 14" x 9" x 23".
- Backed by 3-year warranty.
- Audible and illuminated safety alerts.



## Pureline OC6000 Series Oxygen Concentrators

195.1145.00 OC6000 53 lbs.

195.1148.00 OC6200 53 lbs.

### Benefits:

The OC6000 Series Oxygen Concentrators allow you to get your oxygen for free by converting room air to medical-grade oxygen. This machine is built for veterinary use and is FDA-approved and UL tested.

The OC6200 adapts to work with Matrix VMS, Shor-Line and LEI/Supera M1200 machines.

### Features:

- Energy efficient and costs average of 12 cents a day to operate.
- Delivers up to 5 LPM.
- Backed by 3-year warranty.
- Audible and illuminated safety alerts.
- Features standard DISS fittings.
- Includes storage organizer with lockable wheels.
- Cart holds emergency backup oxygen supply in "E" tank. Oxygen not included.



195.1148.00

## Y-Splitter

195.1113.00 1 lb.

### Benefits:

Connects up to two anesthesia machines to OC8000 or OC8200.

### Features:

- Maintains accurate split flow rates.
- This is the connecting piece that attaches to your O<sub>2</sub> tubing.
- O<sub>2</sub> tubing not included.



## Pureline OC8000 Series Oxygen Concentrators

195.1363.00	OC8000	60 lbs.
195.1364.00	OC8200	60lbs.

### Benefits:

The NEW Pureline OC8000 Series Oxygen Concentrators can deliver on demand up to 8 LPM, allowing them to handle the higher flow rates sometimes needed for oxygen therapy or an additional machine. This makes both ideal for use with oxygen therapy cages. They can be an extra oxygen supply for your anesthesia system as well. Their state-of-the-art manufacturing in the USA uses high-quality components. They are built with safety in mind with oxygen purity and flow safety alarms. They are FDA approved and UL listed.

Additionally, the OC8200 also features a stable "A" frame chassis with low center of gravity and a dual industry standard demand DISS connection. OC8200 also includes empty e-tank and IV pole (oxygen not included). Auxiliary and main supply switches are clearly marked. Also includes heavy-duty shelf with pre-drilled VESA 100 pattern.

### Features:

- For veterinary use only.
- Intended for both oxygen therapy and anesthesia machines.
- Extracts medical grade oxygen (USP 93%) from the air and delivers it up to 8 LPM.
- Connects with industry standard oxygen DISS fittings.
- Includes 10' high pressure green oxygen hose.
- Quiet 53-dBA operation.
- Energy-efficient; costs average of 20 cents per day.
- Small footprint saves valuable floor space.
- Oxygen not included.

*\*Can Supply O<sub>2</sub>*

To up to two anesthesia machines using a Y Splitter.



195.1363.00

Bubble Humidifier not included.



## Waste Gas Evacuation System

195.1105.00 8 lbs.

### Benefits:

This OSHA compliant system uses a sealed evacuation fan to remove waste gases to the outside air, providing a safer working environment.

### Features:

- Built in circuit breaker.
- Hour meter.
- Stainless steel enclosure.
- Permanent mounting brackets.
- 5 year or 5,000 hour warranty.
- High-quality ABEC 7 ball bearing motor.
- Size: 10" x 7" x 8"
- **SPECS:** Inlet and Outlet: 2" PVC or ABS pipe, Electrical: 115V, 50/60 Hz, 0.3 Full Load Amps, Agency Compliance: UL recognized US and Canada (E47479), certified to UL-507 standards from TUV-SUDAmerica, Inc. Certified for US and Canada. Not for sale outside the US and Canada.



## Waste Gas Evacuation Outlet

EVC680 Wall Outlet  
EVC680PS Ceiling Outlet

### Benefits:

Industry standard rough in box (blue) and simple PVC plumbing make these outlets easy to install.

### Features:

- Factory calibrated 22mm inlet nipple.
- Left or Right stud mounting.
- Industry standard 1/2" Schedule 40 fittings.
- Used with Waste Gas Interface Valve.
- **SPECS:** Inlet--22mm male; Outlet--1/2" Schedule 40 female.



## Waste Gas Interface Valve, Model EVC 630

195.1016.00 8 lbs

### Benefits:

All active evacuation systems require a balanced pressure between the suction or fan source and the anesthesia machines. This simple, safe device offers that solution.

### Features:

- 20 feet of 22mm white tubing.
- 4 feet of 19mm blue tubing.
- 3 liter reservoir bag.
- Mounting hardware (for all 2" post).
- 5 year warranty; used with Waste Gas Evaluation Outlets.
- **SPECS:** Capacity: 1-150 lpm flow, Inlet: 19mm male, Outlet: 22mm male

# ANESTHESIA ACCESSORIES

## Vaporizers

195.1160.00	Vaporizer, Isoflurane, Pour	11 lbs.
195.1154.00	Vaporizer, Sevoflurane, Key	11 lbs.
195.1159.00	Vaporizer, Sevoflurane, Pour	11 lbs.

### Benefits:

High quality Northern Vaporizers (Tech 3 style). Isoflurane or Sevoflurane. Available in Pour or Key fill. Anti-Spill Adaptors available.



## Universal Control Arm and Bain Non-Rebreathing Circuit

195.1149.00	Standard Pressure Relief Valve	1 lb.
195.1149.01	Safety Pressure Relief Valve	1 lb.

### Benefits:

Aids in heat and moisture retention, speeding patient recovery time. Premier version features the Premier Safety Pressure Relief Valve.

### Features:

- Single tube to patient design, 40" tube length.



## Unilimb Rebreathing Circuit

195.1032.00	Adult over 20lbs.	1 lb.
195.1033.00	Pediatric 5–20lbs.	1 lb.

### Benefits:

Aids in heat and moisture retention, speeding patient recovery time.

### Features:

- Single tube to patient design, 40" tube length.



## Non-Rebreathing System

195.1034.00	1 lb.
-------------	-------

### Features:

- Quickly connects to the common gas outlet.
- Designed for use with animals <10kg.
- Includes a one liter bag with stop cock built into the evacuation fitting.



## Small Animal Masks

195.1017.00	Small, Feline	1 lb.
195.1018.00	Medium, Canine	1 lb.
195.1019.00	Large, Canine	1 lb.

### Benefits:

Diaphragms stretch for snug fit over muzzle.



## Complete F/AIR Kit

195.1020.00	Complete F/AIR Kit	1.5 lbs.
195.1021.00	F/AIR Canister Only	1.5 lbs.

### Benefits:

Effectively removes waste gases with activated charcoal granules and can be used on any anesthesia machine.

### Features:

- F/AIR canister and canister bracket.
- 22mm x 19mm adapter.
- 4 feet of 19mm blue tubing.
- Screws and wrench for attachment.



## Dual "E" Tank Manifold

195.1001.00	Fits Basic	10 lbs.
195.1181.00	Fits A-Frame	12 lbs.

### Benefits:

Holds two "E" tanks that attach to a mobile base.

### Features:

- Consists of a pressure regulator, green oxygen hose and dual yokes.
- The dual yokes act to orient and support the "E" cylinder, provide a gas-tight seal, and ensure a unidirectional flow of gas into the machine.
- Bottles sold separately.
- Use correct model for Mobile Unit.





# SCALES

## CANINE SCALES

Dependable and durable—Your Shor-Line scale will weigh accurately for decades!!

We know how important an accurate weight is in your treatment, so our scales can be added to many of the tables we make.

The exception is Fold-Up Tables. Those are not compatible with scales.

Call your sales representative and discuss the options.



## BLUE-LINE SCALE COLOR OPTIONS



### Feline Scale LS

905.0400.05 8 lbs.

#### Benefits:

Compact in size to save counter space but large enough to accurately weigh your largest feline. Can weigh small dogs as well.

#### Features:

- Push button zero/tare weight.
- Pound/Kilogram switch.
- 44 lb/20 kg capacity, weighs in .02 lb/10g increments.
- Removable tray for easy cleaning.
- 9 Volt battery (included).
- **Specs:** 9"W x 21"L tray with 2"H lip on either side.

Cats love to crouch down!.



# HOW TO BUY SCALES

## SCALE PLATFORM

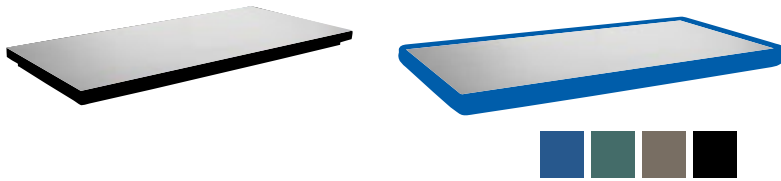

- K9-W8 Platform
- Blue-Line Platform  
Available in Standard Blue, Jade, Taupe Gray or Black.

## MOUNT

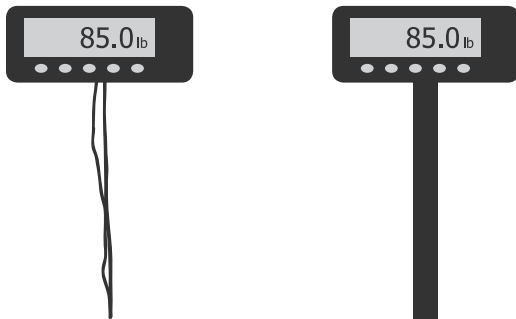

- Wall Mount
- Post Mount

## ADDITIONAL DISPLAYS

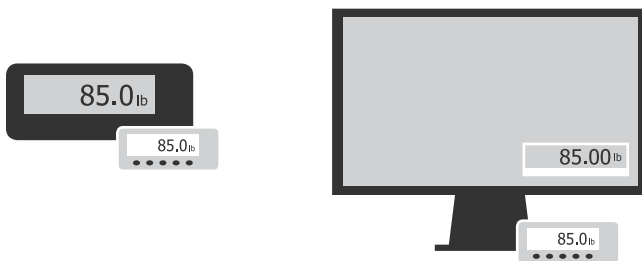

In addition to the mounted display that comes with your scale, you may choose to add

- Remote Display  
This contains two displays—one with operation keys at the weighing platform and another at a remote location, such as an exam room.
- Shor-Connect  
The scale can read and operate both from the display at the scale as well as your computer or tablet. Compatible with XP and Windows 7 and Windows 10.
- None

# BLUE-LINE SCALES

## Blue-Line Scale, Display with Operation Keys

905.3010.05	Wall Mount, Standard Blue	63 lbs.
905.3011.05	Wall Mount, Jade	63 lbs.
905.3012.05	Wall Mount, Taupe Gray	63 lbs.
905.3013.05	Wall Mount, Black	63 lbs.
905.3014.04	Post Mount, Standard Blue	75 lbs.
905.3015.04	Post Mount, Jade	75 lbs.
905.3016.04	Post Mount, Taupe Gray	75 lbs.
905.3017.04	Post Mount, Black	75 lbs.

### Benefits:

The Blue-Line scale enhances your decor but also tough enough to stand up to reception area use.

### Features:

- Low-profile stainless steel platform scale gives accurate and repeatable weights in pounds and/or kilograms.
- Unique polyurethane edge available in four colors.
- Large, easy to see backlit LCD screen with ¾"H numbers.
- Quick, on-screen weight calibration.
- Wall Mount mounts above the scale or another room.
- **Specs:** 44½" L x 22½" W x 3" H.
- 10' data cord extension available; includes 6' power cord.



## Blue-Line Scale, Remote Display

905.3010.08	Wall Mount, Standard Blue	63 lbs.
905.3011.08	Wall M 63 lbs.	
905.3012.08	Wall Mount, Taupe Gray	63 lbs.
905.3013.08	Wall Mount, Black	63 lbs.
905.3014.06	Post Mount, Standard Blue	75 lbs.
905.3015.06	Post Mount, Jade	75 lbs.
905.3016.06	Post Mount, Taupe Gray	75 lbs.
905.3017.06	Post Mount, Black	75 lbs.

### Benefits:

The remote control unit allows a person to weigh the animal in one area, and another person can view a second display located up to 30' away from the weighing platform.

### Features:

- Remote display works best when there is a clear sightline or path from the platform unit.
- Display with operation keys works like other K9-W8 scales and the remote shows only the animal's weight.



## Blue-Line Scale, Shor-Connect

905.3010.07	Wall Mount, Standard Blue	63 lbs.
905.3011.07	Wall Mount, Jade	63 lbs.
905.3012.07	Wall Mount, Taupe Gray	63 lbs.
905.3013.07	Wall Mount, Black	63 lbs.
905.3014.05	Post Mount, Standard Blue	75 lbs.
905.3015.05	Post Mount, Jade	75 lbs.
905.3016.05	Post Mount, Taupe Gray	75 lbs.
905.3017.05	Post Mount, Black	75 lbs.

### Benefits:

The Shor-Connect option combines the features of the Display with Operation Keys with your PC or select Windows tablets.

### Features:

- The display (either post mount or wall mount) with operation keys allows the operator to conduct all weighing tasks, including calibration.
- The Shor-Connect installs on a computer and permits an operator to conduct all the same weighing tasks from the computer.
- Works on computers with Windows 7 + 10 and an available USB port.



# K9-W8 SCALES

## K9-W8 Scale, Display with Operation Keys

905.5010.43 Wall Mount 53 lbs.  
 905.5010.47 Post Mount 67 lbs.

**Benefits:**

We've made the K9-W8 Scale you love even better with new load cell technology and a new combination of materials that delivers incredible accuracy and the ability to withstand years of use.

**Features:**

- Four ultra low profile load cells at each corner provide accurate and repeatable weights in pounds and/or kilograms.
- A liquid-resistant shroud that spans the length of the scale provides protection from routine cleaning for the load cells.
- Large, easy to see backlit LCD screen with ¾" high numbers.
- Tare, recall, lbs/kg, light and free/lock features and quick, on-screen weight calibration.
- Gray, ribbed, non-skid mat provides solid patient footing.
- Post display is powder-coated dark grey, stands 37" high. Slide the slim base under the scale or move it within 4" of the scale.
- Wall Mount can display above the platform or extend down the hall or to another room with data cord extensions.
- **Specs:** 22½"W x 44½"L x 3"H.
- Comes with a 6' power cord. 10' data cord extension available.



Wall Mount Display

905.5010.47

## K9-W8 Scale, Remote Display

905.5010.46 Wall Mount 53 lbs.  
 905.5010.49 Post Mount 67 lbs.

**Benefits:**

The remote control unit allows a person to weigh the animal in one area, and another person can view a second display located up to 30' away from the weighing platform.

**Features:**

- This unit has same features as Post Mount or Wall Mount K9-W8 scale but includes a second remote display.
- Second remote display is for viewing only, and it does not have operating keys.
- Remote display works best when there is a clear sightline or path from the platform unit.
- **Specs:** 22½"W x 44½"L x 3"H.
- Comes with a 6' power cord. 10' data cord extension available.



Remote Display

905.5010.46

## K9-W8 Scale, Shor-Connect

905.5010.45 Wall Mount 53 lbs.  
 905.5010.48 Post Mount 67 lbs.

**Benefits:**

The Shor-Connect option combines the features of the Display with Operation Keys with your PC or select Windows tablets.

**Features:**

- The display (either post mount or wall mount) with operation keys allows the operator to conduct all weighing tasks, including calibration.
- **Specs:** 22½"W x 44½"L x 3"H.
- The Shor-Connect installs on a computer and permits an operator to conduct weighing tasks from the computer.
- Works on computers with Windows 7 and 10 and an available USB port.



Monitor Display

905.510.45



# CRITICAL CARE

## WARMING SYSTEMS

### Warming Pad

912.1000.05	Warming Pad, 120V	10 lbs.
912.1000.06	Warming Pad, 240V	10 lbs.

#### Benefits:

Our Warming Pad is now CSA/UL listed, giving you confidence in the safety, security and functionality of our thermal support for your clients for post-operative and treatment care. It is designed to reduce the risk of hypothermia, which has been proven to be heightened during and following anesthesia.

#### Features:

- Safety is built into this thermal formed, textured pad. The enclosed heating element automatically warms up (about 15 minutes) and maintains a factory-set temperature.
- The controller offers three timed cycle setting options—60, 90 and 120 minutes.
- The alarm helps you monitor the patient. Stand By mode is set to sound an alarm at five minutes and continue to the end of the selected time cycle. Then, a repetitive series of low-tone beeps warn the operator before the pad shuts off.
- If the Warming Pad becomes unplugged or the temperature exceeds the safety shut-down limit, the Alert mode will sound, a red light will illuminate and the pad will start a cool down process.
- The controller connects with a 2' black cable, and you can add one optional 2' cable.
- The controller mounts on a cage door with a stainless steel clip.
- You can use the warming pad in or out of a cage, and its light weight allows for easy transport.
- **Specs:** 20"W x 25"L; designed to fit in a 24" or wider Shor-Line cage. The power cord is 10'. Electrical: 120/240 VAC, 50/60 HZ, .5 A at 120 VAC, .25 A at 240 VAC.



912.1000.05



# OXYGEN THERAPY

## What Shor-Line Cages Can Become O<sub>2</sub> Cages?

Almost all Shor-Line cages back from our Type 1 cages to current models can become oxygen cages. (The exception is 18 x 18" Type 1 or 2 cages.)

To convert a cage, first determine what Type Shor-Line cage you have. If you have black, fiberglass reinforced nylon coating stainless steel hinges, you have Type III cages and can choose a door with no conversion. If you have Type I or II, you will need a retrofit kit in addition to the O<sub>2</sub> door. (This kit will change out the door hinges and/or latch, depending on cage type).

Using the retrofit kit requires minimal tools unless the hinge screws are stripped or otherwise unable to be removed. Our technical support team can give you phone guidance so you can assess your situation before you order. Call 800-444-1579.

Converting one or more cages to O<sub>2</sub> cages gives you an additional tool for supporting your patients, especially the older patients.



1. 7 ft. Cage Assembly Option C
2. Squeeze Restraint
3. 30" x 30" H O<sub>2</sub> door with Pureline
4. OC8000 Oxygen Concentrator attached
5. IV Pump Holder
6. Warming Pad (bottom of cage and control on cage front)
7. Quiet-Time Cage Door Cover
8. PVC Floor Cover

Can provide O<sub>2</sub> to up to 30"W x 30"H cages.

## Oxygen Therapy Doors *New + improved!*

914.1824.10	18" x 24" Single O <sub>2</sub> Door	33 lbs.
914.2418.10	24" x 18" Single O <sub>2</sub> Door	33 lbs.
914.2424.10	24" x 24" Single O <sub>2</sub> Door	33 lbs.
914.2430.10	24" x 30" Single O <sub>2</sub> Door	35 lbs.
914.2436.10	24" x 36" Single O <sub>2</sub> Door	43 lbs.
914.3024.10	30" x 24" Single O <sub>2</sub> Door	38 lbs.
914.3030.10	30" x 30" Single O <sub>2</sub> Door	38 lbs.
914.3036.10	30" x 36" Single O <sub>2</sub> Door	33 lbs.
914.3624.10	36" x 24" Single O <sub>2</sub> Door	33 lbs.
914.3630.10	36" x 30" Single O <sub>2</sub> Door	43 lbs.
914.3636.10	36" x 36" Single O <sub>2</sub> Door	43 lbs.
914.4230.10	42" x 30" Single O <sub>2</sub> Door	33 lbs.
914.4830.10	48" x 30" Single O <sub>2</sub> Door	33 lbs.
914.4836.10	48" x 36" Single O <sub>2</sub> Door	43 lbs.

### Benefits:

Oxygen therapy doors help you give additional oxygen support to your patients. Add this to your ICU offerings or make it part of a "step down" unit.

### Features:

- The ¼" thick clear PETG (Polyethylene Terephthalate Glycol) door has removable autoclavable gaskets.
- Semi-disposable humidifier (3 included) positioned in a removable chamber allows you to cool the water with ice or warm with water.
- Digital readout for temperature/humidity with minimum and maximum memory function and Celcius or Fahrenheit temperature readout.
- Cage sold separately.
- 110V AG



## Clear PETG Door for Oxygen Therapy Conversion

914.2430.11	24" x 30" Single Door	50 lbs.
-------------	-----------------------	---------

### Benefits:

Kit allows you to convert a standard 48" x 30" Double Door Cage into an oxygen therapy holding unit for larger patients. Left side needs to be an existing O<sub>2</sub> door (Sold separately, see above). Remove right side cage door and replace with solid PETG (Polyethylene Terephthalate Glycol) door.

**(Note:** Retrofit kit needed for Type I and II doors.)

### Features:

- ¼" thick clear PETG (Polyethylene Terephthalate Glycol) allows for maximum light and view of patients.
- Conversion kit design uses a 24"W x 30"H clear plexiglass door and removable gasket seals for your cages.
- Cage and O<sub>2</sub> door sold separately.
- 110V AG



Clear PETG Door

## Mobile Transport with O<sub>2</sub> Door

914.3630.50 176 lbs.

### Benefits:

Perfect for hospitals with small staffs. You can roll the Oxygen Therapy Unit to any area with electricity for maximum patient visibility and easy monitoring by team members.

### Features:

- Same simple operation as O<sub>2</sub> door.
- 5" casters and push handle allow for easy movement.
- Cage top surface provides space for extra work area or monitoring equipment.
- **Specs:** 40¾"W x 38"H x 30¾"D



## Assisted Care Console (ACC)

802.2400.10	ACC I, 24" H	10 lbs.
802.3000.10	ACC I, 30" H	10 lbs.
802.3600.10	ACC I, 36" H	10 lbs.
802.2400.11	ACC II, 24" H	12 lbs.
802.3000.11	ACC II, 30" H	12 lbs.
802.3600.11	ACC II, 36" H	12 lbs.
802.2400.12	ACC III, 24" H	14 lbs.
802.3000.12	ACC III, 30" H	14 lbs.
802.3600.12	ACC III, 36" H	14 lbs.

### Benefits:

Eliminate dangling power cords, IV tubes and oxygen lines hanging from the ceiling or draping across cage doors.

### Features:

- Assisted Care Console fits between Shor-Line cages.
- The ACC is 6" wide and is available in 24", 30" and 36" high.
- ACC I includes 33" long adjustable IV Pole and IV Pump Holder.
- ACC II, same as ACC I plus GFI (Ground Fault Interrupter) Electrical Outlet.
- ACC III, same as ACC II plus Ohmeda O<sub>2</sub> Female Outlet.

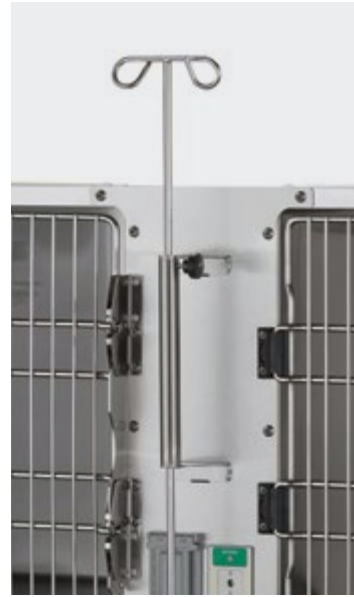

## Bubble Humidifier

025.0004.00 2 lbs.

### Benefits:

Delivers moist supplementary O<sub>2</sub> to the bronchial passages.

### Features:

- Humidifier is semi-disposable. Can be cleaned and reused several times.



## Oxygen Regulator and Flowmeter Combo

195.1015.00	Combo	3 lbs.
195.1049.00	Flowmeter only	3 lbs.

### Benefits:

Delivers precise amounts of oxygen to Shor-Line's oxygen therapy doors. Oxygen regulator adjusts the tank pressure to the usable pressure and rate from the Flowmeter.

### Features:

- 10'-long hose and DISS female fitting.
- 0-15 LPM adjustment.
- Protected by an all-metal housing.

# IV PRODUCTS

## IV Holder, Rail Attachment

803.0006.10 4 lbs.

### Benefits:

IV fluid holder length allows just enough gravity that fluids remain level in all surgical table positions.

### Features:

- Holder features an extra-long, 48" pole.
- Fits any Shor-Line surgery table with a rail system.
- Locks into any position along the attachment rail.
- Kit includes dual hook IV pole and sliding block.



## Mobile IV Stand

803.0010.02 14 lbs.

### Benefits:

IV caster base is made from four epoxy-coated steel legs providing flexibility to place IV fluid where you need it.

### Features:

- Dual wheel casters designed for hard surface floors.
- 1" chrome-plated tree is adjustable from 64" to 96".
- Two-hook IV holder.



## IV Pump Holder

802.0011.00 3 lbs.

### Benefits:

Easily mounts to any Shor-Line cage providing a stable support for your infusion pump. No more tripping over tubes and wires. Allows direct access to infusion pump readouts and controls.

### Features:

- Fits securely over the horizontal bars in any Shor-Line cage.
- The weight of the pump and a twist clasp locks the holder onto the cage bars.
- Height-adjustable dual horn bag hooks for multiple sets.
- IV Pump not included.





### Cage Door IV Holder

802.0001.00	19" Long	3 lbs.
802.0001.01	35" Long	4 lbs.

**Benefits:**

Keeps the floor and aisle space clear from mobile IV stands by attaching your fluids to a cage door.

**Features:**

- Easily attaches to any Shor-Line cage door.
- Sturdy 3/8"-diameter stainless steel rod provides needed strength.
- **Height specs:** 19" holder adjusts from 2" to 16" above the point of attachment to the door; 35" holder adjusts from 2" to 32".



### IV Track Ceiling Mount System

914.0100.01	30 lbs.
-------------	---------

**Benefits:**

Whether in surgery, surgery preparation or ICU wards, the IV Track System allows you to position IV fluids where you need it.

**Features:**

- Simple twist and lock system for horizontal positioning.
- Button release system provides the flexibility to raise and lower fluids to the desired height.
- Four-hook assembly with extra hook at the bottom supply sufficient hanging space for your fluids.
- Track is constructed of extruded aluminum and comes in a standard 4 ft. length. Additional tracks are available in one-foot increments.
- IV Pole is 34" long.



### Cage Assembly Support Brackets for IV Track System

814.0100.22	Mid Support Bracket	1 lb.
814.0100.23	End Support Bracket	1 lb.

**Benefits:**

Provides support at points where two cages are joined together. Purchase IV Track Ceiling Mount System (above) to join any cages. Works with all Shor-Line cages.

**Features:**

- Made from heavy-gauge stainless steel.
- End supports are used at the end of a cage bank.
- Includes: Bracket only.
- Mid Support bracket is used in the middle.
- If continuing lengths are desired, we recommend using a support bracket for every 4' length.

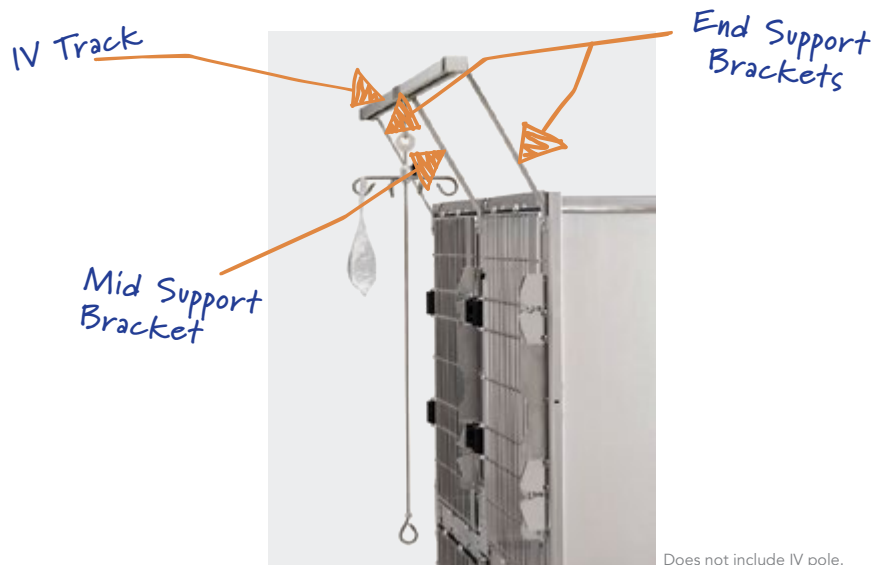

Does not include IV pole.

# SPECIALTY + DIAGNOSTIC

## MICROSCOPES + LIGHTS

### M250 LED Microscope

910.0200.09	250 LED	20 lbs.
910.0200.11	250 LED with Carry Case	21 lbs.

#### Benefits:

The rugged construction of this high-quality microscope works well at your practice. The sealed optics, anti-fungal coating and lighting make it easy to use. Most importantly, it delivers optical quality superior to other microscopes at this price level.

#### Features:

- Seidentopf binocular head.
- DIN achromatic objectives: par-focal, par-centric and color coded 4x, 10x, 40x, 100x (oil).
- Wide-field 10x/18 eyepieces.
- Pre-centered Abbe condenser. N.A. 1.25 with iris diaphragm and filter holder.
- Coaxial coarse and fine focusing with safety stop.
- LED illumination rated at 10,000 hours.
- Five-year limited warranty.
- 110 V



### IP730 Microscope

910.0100.76	21 lbs.
-------------	---------

#### Benefits:

The IP730 Microscope from Shor-Line is an excellent basic tool for your standard tasks, (fecal exams, fungal tests, routine hematology, urine sediment exams, gram stains, etc.).

#### Features:

- Seidentopf binocular head.
- Koehler-type illumination and variable light intensity without losing any acuity or brightness.
- Ergonomically designed for comfort during extended use.
- Achromatic objectives: 4x, 10x, 40x, 100x (oil).
- Coaxial coarse and fine focusing system help.
- Focusable and centerable N.A. 1.25 Abbe condenser with graduated iris diaphragm and filter holder.
- Wide-field 10x/22 eye pieces.
- Five-year limited warranty.
- 110 V



# CENTRIFUGES

## Micro-Hematocrit Centrifuge

910.0200.05 21 lbs.

### Benefits:

Our basic model delivers dependable performance at an economical price.

### Features:

- 24-place capillary tube rotor.
- Fixed 12,000 RPM.
- 0-5 minute timer with bell.
- Safety shut-off lid.
- Reader with Hematocrit Percent Scale included.



## Power Spin FX Centrifuge

910.0200.08 15 lbs.

### Benefits:

This entry model gives reliable operation with dependable results, giving good value for your practice.

### Features:

- Has 3,400 RPM fixed speed.
- Six place tube rotor.
- 0-30 minute timer with bell.
- Latchable safety lid.
- Rotor chamber accessible for cleaning.



## Power Spin LX Centrifuge

910.0200.07 18 lbs.

### Benefits:

The most powerful centrifuge with variable linear speed in this price range. The extra power provides a more complete separation of cellular components from a wide range of fluids.

### Features:

- Two-2 ml and six-4/5 ml tube adapters included.
- Has variable speed from 300-4000 RPM.
- Color-coded panel with suggested speeds for fecals (1500 RPM), urine (2000 RPM) and blood (3400 RPM).
- Six place tube rotor.
- 0-30 minute timer with bell.
- Latchable safety lid.



## Power Spin DX Centrifuge

910.0200.28 33 lbs.

### Benefits:

The PowerSpin™ DX has variable speed 500-4000 RPM to ensure a clean and complete separation. Quiet and dependable, it has a maintenance-free motor. Use it to process blood, urine, semen and other specimens. This Horizontal Spin Centrifuge is preferred for fecal evaluations.

### Features:

- Zero RPM Safety Latching System prevents lid from being opened while rotor is spinning.
- Quiet running—only 50 decibels at 3400 RPM.
- 99 minute digital timer adjusts to 1-second increments.
- Remembers last setting for quick repeat runs.
- Adjustable acceleration and deceleration.
- Stainless steel rotor chamber for easy cleaning.
- Suction cup rubber feet eliminate vibration.
- Available in 110/220V, 50/60HZ.

# AUTOCLAVES

Both manual and automatic autoclaves will sterilize your equipment using steam. The main choice is how much hands-on time you are willing to devote to the machine.

**Manual.** You manually set the unit to fill, and then you load and set the cycle and dry times. There are automatic shut-offs to the units we carry, but someone does need to actively participate in the process.

**Automatic.** You will initially need to program the cycles you want to run for sterilization. After that, it is as simple as loading and pressing the needed pre-programmed cycle.

Whichever you choose, use the tray dimensions and capacity to determine the best size for your practice.

## Tuttnauer Automatic Autoclaves

910.0100.32	EZ9	95 lbs.
910.0100.33	EZ10	95 lbs.

**Benefits:**

Fill, sterilize, exhaust and dry at the touch of a button.

**Features:**

- Closed-door active drying system maintains sterility and ensures efficient pack and pouch drying.
- High-efficiency air pump circulates hot air after the sterilization cycle for fast drying.
- HEPA filter .2µm air filter (replaceable).
- Pre-loaded cycles for unwrapped instruments, wrapped/packs, liquid and additional drying cycle.
- You can customize and store all program parameters.
- Automatic shut-off at the end of both the sterilization and dry cycles.
- Audible and visual cycle interruption alert.
- Double safety locking device prevents door from opening while chamber is pressurized.
- Low-water sensor prevents activation of sterilization cycle when there is insufficient water in the chamber or reservoir.
- Power outage recovery system.
- Door design prevents steam from coming in contact with control panel.
- Optional printer available.
- 510k clearance for dental hand pieces.
- Two-year parts and labor warranty.



910.0100.32

\* See below for details.

## Tuttnauer Manual Autoclaves

910.0100.30	2340M	85 lbs.
910.0100.31	2540M	85 lbs.

**Benefits:**

These basic manual autoclaves from Tuttnauer will satisfy all the sterilization needs of most veterinary hospitals.

**Features:**

- Automatic shut-off at the end of both the sterilization and dry cycles.
- Electro-polished chamber and door for long life against corrosion.
- Double safety locking device prevents door from opening while chamber is pressurized.
- Overheat shut-off prevents burnout of heating elements in case of insufficient water in the chamber.
- Drain valve is located on the front, allowing quick and easy draining of water reservoir.
- One-year parts and labor warranty.



910.0100.30

Model	Chamber Dimensions	Volume	Overall Dimensions D x W x H	Standard Cassette Capacity	Tray Dimension	# of Trays	Standard Unwrapped Cycle
<b>EZ9</b>	9" x 18"	5 gallons	21.5" x 20" x 14.4"	2 full & 2 half	6.7" x 16.3" x 0.8"	3	Cold: 27 min., Hot: 13 min.
<b>EZ10</b>	10" x 19"	6 gallons	21.5" x 20" x 14.4"	3 full & 3 half	6.7" x 16.3" x 0.8"	4	Cold: 30 min., Hot: 14 min.
<b>2340M</b>	9" x 18"	5 gallons	21.5" x 20" x 14.4"	2 full & 2 half	6.7" x 16.3" x 0.8"	3	Cold: 27 min., Hot: 13 min.
<b>2540M</b>	10" x 19"	6 gallons	21.5" x 20" x 14.4"	3 full & 3 half	6.7" x 16.3" x 0.8"	4	Cold: 30 min., Hot: 14 min.

## ACCESSORIES

### Narcotics Cabinet

918.0005.11 Single Door, Double Lock 18 lbs.

#### Benefits

Sturdy, dependable narcotics cabinet keeps narcotics secure and limits access.

#### Features

- High-security, pick-resistant tubular lock.
- Single door with double lock.
- Made from 20-gauge steel.
- All cabinets are keyed differently, providing a unique lock sequence.
- Full Stainless Steel pinned door hinges prevent pin removal.
- Four keys per lock included.
- Includes one adjustable shelf that can locate in one of four places inside the cabinet.
- Available in beige.
- 12-year limited warranty.
- Specs: 15"W x 12"H x 8"D.



918.0005.11



### X-Ray Apron

918.0006.18 11 lbs.

#### Benefits:

0.5 mm pb apron provides excellent protection while remaining lightweight and comfortable to wear for extended periods of time.

#### Features:

- One size fits most.
- Blue nylon material is durable and easy to clean.
- Wrap-around Velcro® closure.



### X-Ray Mittens

918.0006.17 6 lbs.

#### Benefits:

Open palm allows you to position and secure the patient while providing protection.

#### Features:

- 0.5 mm pb protection.
- Lined with soft but durable expanded foam.
- Blue nylon material is durable and easy to clean.
- 15" Long



### X-Ray Rack for Apron and Mittens

918.0006.19 11 lbs.

#### Benefits:

Provides a convenient way to store your apron and gloves while protecting them from damaging wrinkles.

#### Features:

- Durable, powder-coated white finish.
- Apron and mittens sold separately.



### Thyroid Collar

918.1006.81 21 lb.

#### Benefits:

Gives 0.5 mm pb equivalent protection of neck area above the standard apron.

#### Features:

- Nylon material is durable and easy to clean.
- Accommodates neck sizes up to 20 inches.
- Convenient Velcro® closure.



# DIAGNOSTIC EQUIPMENT

## HEINE VET Diagnostic Set

910.0501.16 Vet Diagnostic Set 6 lbs.

### Benefits

Wall-Mount set keeps your diagnostic set handy during exams.

### Features

- **K180® Ophthalmoscope 3.5V** is a full-featured instrument at an economical price.
- It uses Xenon Halogen technology to provide bright, white light for a clear retinal image.
- Includes ergonomic features, including a soft orbital rest for users with glasses.
- Has a choice 5 apertures and a choice of fixation star of Cobalt Blue filter.
- **BETA100 Diagnostic Otoscope** with long-lasting, all-metal construction and Xenon Halogen illumination.
- This versatile otoscope can be used with very small animals and will accept reusable veterinary specula. Has 2.5x magnification.



## HEINE Diagnostic Set In Case

910.0500.01 Diagnostic Set 5 lbs.

### Benefits

A complete diagnostic set available in a convenient zippered storage case.

### Features

- K180® Ophthalmoscope 3.5V is a full-featured instrument at an economical price. It uses Xenon Halogen technology to provide bright, white light for a clear retinal image.
- Includes ergonomic features, including a soft orbital rest for users with glasses. Has a choice 5 apertures and a choice of fixation star of Cobalt Blue filter.
- BETA100 Diagnostic Otoscope with long-lasting, all-metal construction and Xenon Halogen illumination. This versatile otoscope can be used with very small animals and will accept reusable veterinary specula. Has 2.5x magnification.
- Reusable Salalon VET specula.
- BETA R rechargeable handle for main socket.



## HEINE Economy Laryngoscope Set

910.0500.33	Standard LED Handle	1 lbs.
910.0500.34	Blade, Miller #2, Sanalon	1 lbs.
910.0500.35	Blade, Miller #4, Sanalon	1 lbs.
910.0500.36	Blade, Miller Pediatric, Sanalon	1 lbs.

### Benefits

- These items make up the Economy Laryngoscope Set.
- Xenon Halogen illumination technology dramatically improves your view of the epiglottis and vocal cords.
- The two-piece handle design allows you to sterilize the outer sleeve while the inner illumination compartment is protected. This prolongs product life.

### Features

- Lightweight, full-metal construction.
- Cost-effective, high-quality battery handle with Sanalon+ connector.
- Offering Miller Pediatric, #2 and #4 (not shown) blades.



# TERMS + CONDITIONS

**1. ORDER & ACCEPTANCE** By submitting an order for the products, Buyer shall have agreed to purchase the products subject to all Seller's terms including these TERMS and CONDITIONS. Buyer's order is subject to and effective only upon acceptance and approval at Seller's offices in Kansas City, Kansas as evidenced by Seller's issuance of an Order Acknowledgement or Invoice. Processing of an order shall not commence until receipt of any applicable deposit and all required paperwork and customer sign-offs. The resulting contract shall be deemed made in Kansas and shall in all respects be governed and interpreted according to the laws of the State of Kansas. Buyer also consents to the jurisdiction of Kansas courts over any dispute involving an order.

**2. ENTIRE AGREEMENT** An order as accepted and approved by Seller constitutes the entire final agreement between the parties. Except as otherwise provided in writing by Seller, the terms set forth herein constitute the sole TERMS AND CONDITIONS for Buyer's order. Seller's acceptance of Buyer's order is expressly conditioned on Buyer's assent to these TERMS AND CONDITIONS which may not be supplemented, modified, superseded or otherwise altered except as authorized in writing by Seller. Any different, conflicting or additional terms in Buyer's purchase order or any other document of Buyer are rejected and Seller's TERMS AND CONDITIONS shall prevail.

**3. TERMS OF PAYMENT** Unless otherwise expressly specified by Seller in writing, payment shall be due 30 days from the date of invoice, payable in U.S. Funds. Seller reserves the right to negotiate terms or orders of any unique or special nature and may require full or partial payment in advance in its sole discretion. Acceptance of all orders and the payment terms for such orders are subject to approval by Seller's Credit Department. Seller may decline to make any shipment or perform any work except upon terms satisfactory to said Department. A charge of 1½% per month (or the highest monthly interest rate that may be imposed under applicable law) will be imposed on overdue accounts. Buyer will be liable for all expenses (including reasonable attorneys' fees) incurred in collecting any overdue accounts.

**4. PRICES & QUOTES** Prices on products are F.O.B. Seller's factory unless otherwise specified in writing and are exclusive of any city, state, local or federal tax. Prices are subject to adjustment without notice and Seller reserves the right to correct errors in prices or specifications. Any quotation (whether written or oral) is not an offer to contract or acceptance of an order. Similarly, neither a price list nor a catalog constitutes an offer to sell or contract, but are provided solely for customers' convenience.

**5. TAXES** Any sales, use, property, or other taxes or duties which Seller may be required to pay or collect (under any existing or future law) in connection with the sale, purchase, delivery, storage, processing, consumption or use of the products shall be for the account of Buyer and Buyer shall promptly reimburse Seller therefore.

**6. DELIVERIES** Delivery dates are estimates only and time shall not be of the essence unless specifically provided by Seller in writing. Seller will not have any liability for loss or damage resulting from a delay in a scheduled delivery or for non-delivery resulting from labor trouble, part or material shortages, accident, fire, war, strike, natural disaster, carrier delays or any contingency whatsoever (whether of the same class of those enumerated or otherwise) beyond its reasonable control. Buyer assumes all freight, handling and installation costs and the risk of loss or delay in transit. Seller will assist Buyer with transit arrangements, but Seller shall be free of any liability in connection therewith. Title to all materials and products sold by Seller shall pass to Buyer upon delivery to the carrier and Seller's responsibility ceases at that time. Risk of loss, injury, or destruction of the products shall be

borne by the Buyer and any such loss, injury or destruction shall not release Buyer from payment of the purchase price.

**7. INSPECTION** Buyer must inspect all materials for shortages, damages, conformity with order and defects before signing any documentation requested by the carrier. Buyer must immediately complete such inspection and shall not accept delivery of goods that are damaged or not in accordance with the bill of lading or packing slip without proper notification to the carrier and Seller. If goods are damaged, defective, shorted or appear not to conform to the order, Buyer shall discontinue their use and immediately notify the carrier and Seller of such condition and afford a reasonable opportunity to inspect the same. Buyer shall make, or provide Seller in writing with all information necessary to make, a claim against such carrier for any shortage, damage, or discrepancy of the shipment within fifteen (15) days after receipt of the goods. Claims or written information thereon not so presented within fifteen (15) days after receipt of the goods will not be allowed. No products will be taken back and credited or replaced unless arrangements for their return have been made in compliance with Seller's Return Policy stated below. SEE SELLER'S CATALOG FOR INFORMATION ON HOW TO FILE A FREIGHT CLAIM.

**8. PRODUCT SATISFACTION** In the event Buyer is not fully satisfied with the quality or workmanship of a product, Seller in its sole discretion may arrange either to credit Seller's account (excluding shipping and handling costs) or replace the product. However, Buyer must notify Seller in writing of its dissatisfaction within fifteen (15) days of receipt of the product from Seller and immediately discontinue its use. Buyer also must return the rejected product to Seller freight paid within thirty (30) days of its receipt in compliance with Seller's Return Policy stated below. Seller's obligation is limited to providing the applicable credit or product replacement, which will be processed only after receipt of the returned product. In addition, this Product Satisfaction policy does not apply to specially designed, discontinued, used, factory second or repaired products.

**9. LIMITED WARRANTY** Seller warrants to the initial purchaser only of products manufactured by it that such products are free from defects in materials or labor for varying periods depending on the particular product and subject to the limitations and conditions set forth herein. Seller's stainless steel products are warranted to be free from such defects for their normal useful life. Seller's mechanical and electrical products, parts, devices and components (including such parts, devices and components of stainless steel products), and other-non-stainless steel products are warranted to be free from such defects for only one year. Seller disclaims any express or implied warranty for products not manufactured by Seller and the only warranty available therefore to Buyer is that offered by the products' manufacturers.

The warranty period shall run from the date of delivery to Buyer. If within the applicable warranty period a product proves to be defective as described herein, Seller will repair or replace the product, at Seller's sole discretion, conditional upon Buyer's written notice of the defect within fifteen (15) days after its discovery. Upon receipt of Buyer's notice including substantiation of Buyer's status as the initial purchaser and details of the defect, Seller shall advise Buyer whether it plans to repair or replace the product. Seller's obligation is solely limited to repair or replacement of a defective product and in no event shall Seller be liable for transportation from or to Seller's offices or any other expense which may arise in connection with this Limited Warranty or the aforementioned Product Satisfaction policy.

SELLER MAKES NO OTHER WARRANTY OR GUARANTEE OF ANY KIND WHATSOEVER, WHETHER EXPRESS OR IMPLIED, STATUTORY OR OTHERWISE INCLUDING, BUT NOT LIMITED TO IMPLIED WARRANTIES OF FITNESS, AND/OR MERCHANTABILITY. THE ABOVE LIMITED WARRANTY CONSTITUTES SELLER'S ONLY WARRANTY AND NO PERSON OR ENTITY IS AUTHORIZED, ON BEHALF OF THE SELLER, TO MODIFY OR EXPAND UPON THE PROVISION EXPRESSED IN THIS PARAGRAPH NUMBER NINE. THE SELLER'S LIABILITY UNDER THIS LIMITED WARRANTY SHALL BE LIMITED AS

PROVIDED FOR ABOVE AND THE FOREGOING SHALL BE THE BUYER'S SOLE REMEDY AND RECOURSE. There are no warranties which extend beyond the description on the face hereof and goods are sold as is. Seller's Limited Warranty is only available to the initial purchaser of its products and is effective only upon compliance with the terms set forth herein.

Buyer agrees that the products subject to this Limited Warranty will be properly maintained in the ordinary course of business. Buyer agrees to comply with all instructions and specifications furnished by Seller relating to the installation, care, use and application of products purchased. Buyer agrees that it will not modify, misapply, or misuse such products in any manner which would deviate from Seller's instructions. Any repairs, alterations or service provided by parties other than Seller, or its authorized representative, may void this Limited Warranty. This Limited Warranty shall not apply to normal wear and tear, improper or insufficient maintenance, routine maintenance, or damage caused by accident, negligence, improper operation or the use of corrosive materials (including without limitation bleach or sodium hypochlorite used on stainless steel surfaces). THE SELLER'S LIMITED WARRANTY SHALL NOT BE EFFECTIVE AND SHALL BE VOID UNLESS GOODS ARE APPLIED AND USED IN ACCORDANCE WITH SELLER'S INSTRUCTIONS.

**10. LIMITATION OF LIABILITY** UNDER NO CIRCUMSTANCES SHALL SELLER BE LIABLE TO BUYER OR ANY OTHER PERSON FOR ANY SPECIAL, LIQUIDATED, INCIDENTAL OR CONSEQUENTIAL DAMAGES, INCLUDING, WITHOUT LIMITATION, DAMAGES BASED UPON LOST GOODWILL, LOST SALES OR PROFITS, WORK STOPPAGE, DELAY, PRODUCT FAILURE, IMPAIRMENT OF GOODS OR OTHERWISE AND WHETHER ARISING OUT OF BREACH OF WARRANTY, BREACH OF CONTRACT, NEGLIGENCE OR OTHERWISE, and in any case, Seller's liability for any and all losses and damages sustained by Buyer and others shall not exceed the original purchase price of the product(s) upon which liability is founded.

IN NO EVENT SHALL ANY ACTION BE COMMENCED AGAINST THE SELLER MORE THAN ONE YEAR AFTER THE CAUSE OF ACTION WITH RESPECT TO WHICH THE CLAIM IS MADE HAS ACCRUED. SELLER SHALL NOT BE RESPONSIBLE FOR EXPENSES FOR REPAIRS NOT MADE BY SELLER WITHOUT THE PRIOR WRITTEN CONSENT OF SELLER.

**11. RETURN POLICY** All products being returned for any reason or delivered for repair service (whether or not pursuant to the Limited Warranty) must receive advance authorization from Seller. Buyer must contact Seller's Technical Service Department at 1.800.444.1579 to receive a Return Authorization Number. All products returned, except for warranty service or pursuant to the Product Satisfaction policy, are subject to a minimum 15% restocking charge. Buyer will be responsible for all freight charges on returns.

**12. INDEMNITY** Buyer agrees to protect, defend, indemnify and hold harmless the Seller from and against any and all direct loss suffered and any liability to third parties due to bodily injury (including death) to any person or animal, or damage to any property as a result of Buyer's misuse, misapplication or failure to inspect or maintain the Seller's products, or such loss or liability caused by the act or omission of the Buyer in the performance of any services using said products. Buyer also agrees to indemnify and hold harmless the Seller for any taxes paid as discussed in paragraph five above. This indemnity provision expressly includes attorney's fees and settlements of claims in a reasonable manner under the circumstances.

**13. UNLAWFUL USE** Buyer agrees that no goods shall be used in any manner violative of any laws of the United States, whether state or federal, or local ordinance, and no such goods shall be distributed to any foreign country in any manner prohibited by United States law.

**14. REGULATIONS AND CODES** Seller makes no representation or promise, express or implied, that goods delivered will conform to any state or local laws, regulations, codes, ordinances, or standards, except as particularly and expressly specified and agreed upon for compliance in writing as a part of the contract

between Buyer and Seller.

**15. SELLER'S REMEDIES** Seller hereby expressly reserves all remedies provided for by the Uniform Commercial Code and such remedies are expressly cumulative in nature and include all of the available remedies for breach and Seller need not make any election of remedy.

**16. MISCELLANEOUS** Buyer may not assign its rights or duties relative without Seller's written consent, but Seller may assign its interest in such order to any affiliate or successor in interest. The waiver of any breach of these TERMS AND CONDITIONS shall not constitute a waiver as to any further breach. Any of these TERMS AND CONDITIONS found to be invalid, illegal or unenforceable, shall be considered inoperative and the remaining TERMS AND CONDITIONS shall be valid and enforceable as though such provisions are not included herein.

## BILLING TERMS

### Shipping & Handling

Freight rates are calculated at the time the order is taken. Freight is charged on all orders unless otherwise stated. Payment options, freight and tax are based on shipments within the U.S. Shipments outside the U.S. will be quoted at the time of the order.

Contact our Credit Department toll-free for questions:  
1.800.444.1579

## DELIVERY OF PRODUCT

We use the following methods of freight for small shipments:

- Express Saver (Ground, 3-6 day service)
- Standard Overnight
- 2 Day Collect (payment is collected at the time the order is delivered)
- Pick-Up (customer may pick up their shipment at our warehouse in Kansas City, KS and save on all freight charges)

Equipment over 70 lbs. will be shipped by common carrier or vanline service (4-6 day service). Call one of our sales representatives at 800.444.1579 for a freight quote. Alaska/Hawaii/Canadian and International shipments require special freight quotes.

### Delivery Terms

Delivery options are listed below and should be discussed at the time the order is taken. Some of our equipment is heavy and/or bulky and can't be delivered utilizing normal delivery procedures. Therefore, Customers have the option of requesting "special delivery" instructions. There may be some confusion regarding special delivery services, the terms used, what services are actually provided and the associated fees. Therefore, we feel it is best to explain the delivery terms and the types of services.

We highly recommend that all orders for CoJack Tables, Electric Lift Tables, Surgery Tables, Tub/Treatment Tables, Exam Cabinet Tables, 60" x 36" and 72" x 36" Double-Door Kennels, Cat Condos, Run Systems and all Mobile Transport Kennels be shipped with "Inside Delivery--Call for Assistance" Instructions. (There is an additional charge for this service.)

We recommend you consider using "Inside Delivery-Assistance Provided" as these items are extremely heavy. (Universities and government agencies are excluded unless expressly specified). The following terms explain optional services available through commercial freight lines. There will be extra charge for the services noted below under items 2, 4, and 5 which will be added to your invoice

1. Call Before Shipping - A Shor-Line representative will call Customer before shipping the product from the factory to ensure the Customer is ready to receive the equipment. This is primarily used for new clinics that will be opening or customers with irregular working hours.
2. Call Before Delivery for Assistance - Trucking company will call Customer before delivery so that Customer can make arrangements to have adequate personnel to lift item off the truck

and carry into the clinic. But the driver is not required to assist in unloading item off the truck. The driver is only responsible for getting the product to the rear of the truck. (Adequate "Call for Assistance" personnel must be at least three people that are able to lift heavy equipment.)

3. Inside Delivery-Call for Assistance - Trucking company will call before delivery so that Customer can make arrangements to have adequate personnel to assist the driver in taking the equipment off the truck and carrying it into the clinic. (Adequate "Inside Delivery" personnel must be at least three people that are able to lift heavy equipment.)

4. Liftgate Service - For items that are too heavy and cumbersome to safely lift off the back of the truck.

5. Manpower - Manpower to unload equipment can be provided to unload on vanline orders.

All optional services must be requested at time equipment is ordered and will be reflected on the Customer Order. Optional services requested by the Customer will be billed with the order by Shor-Line. Bills-of-lading will carry the following statement: Any Additional Charges Will Be Paid By the Customer. Please be aware that these delivery services are optional and must be requested at the time the order is placed.

Note: Keep in mind that if the truckline is unable to make delivery and there are no special delivery instructions, the redelivery charge will be billed to the customer.

Call our Customer Service Department (1.800.444.1579) for the fees associated with these services. \*These product delivery terms are for U.S. and Canada. For other countries, contact your Shor-Line distributor for local delivery terms.

Contact our Traffic Department toll-free at 1.800.444.1579 for additional questions.

## DAMAGES/RETURNS/REPAIRS

FIRST, contact our Technical Services Department toll-free at 1.800.444.1579.

### How To File A Freight Claim

1. Inspect ALL packages upon arrival. If containers show evidence of damage when delivered the packages should be opened immediately before the driver leaves. The shipment should be inventoried and inspected jointly by the Customer and the driver. The driver will then make proper notation on the delivery receipt.

Customer must inspect all materials for shortages, damages, conformity with order and defects before signing any documentation requested by the carrier. Customer must immediately complete such inspection and shall not accept delivery of goods that are damaged or not in accordance with the bill of lading or packing slip without proper notification to the carrier and Shor-Line. If goods are damaged, defective, shorted or appear not to conform to the order, Customer shall discontinue their use and immediately notify the carrier and Shor-Line of such condition and afford a reasonable opportunity to inspect the same.

Customer shall make, or provide Shor-Line in writing with all information necessary to make, a claim against such carrier for any shortage, damage, or discrepancy of the shipment within fifteen (15) days after receipt of the goods. Claims or written information thereon not so presented within fifteen (15) days after receipt of the goods will not be allowed. No returned products will be accepted, credited or replaced, unless arrangements for their return have been made in compliance with Shor-Line's Return Policy. If containers do not show evidence of damage, there may be "concealed damage". Customer must report any concealed damage within 15 days after receipt of the shipment. All packaging and contents must be held for this inspection.

2. Customer must check goods, contents against packing slip, weight against bill of lading, containers, etc.

3. Customer fills out "Inspection Report of Loss or Damage Discovered After Delivery" (a standard form).

4. Call Shor-Line's Technical Services Department to file a claim (1.800.444.1579).

5. Customer and consignee both sign the "Inspection Report of Loss or Damage Discovered After Delivery" form. A copy is left with the consignee and should be forwarded to Shor-Line's TECHNICAL SERVICES department.

### Return Policy & Repairs

All products being returned for any reason or delivered for repair service (whether or not pursuant to our Limited Warranty) must receive advance authorization from Shor-Line. Customer must contact Shor-Line's Technical Service Department at 1.800.444.1579 to receive a Return Authorization. All products returned, except for warranty service or pursuant to the Product Satisfaction policy, are subject to a minimum 15% restocking charge. Customer will be responsible for all freight charges on returns.

### Return Product Authorization

To assure efficient handling on damaged or defective equipment, or repairs, please contact our Technical Service Department for Return Product Authorization (1.800.444.1579). Failure to obtain Return Product Authorization will only delay the processing of your matter and may result in the denial of any repair, replacement or credit.

### Repairs

Repairs are handled by the Technical Service Department at 1.800.444.1579. It is mandatory you contact them prior to sending in your product for repair.

**All Shor-Line products are intended for animal use only and none of the products constitute medical equipment to be used in connection with any human medical applications.**

# CONTACT US

CONTACT US

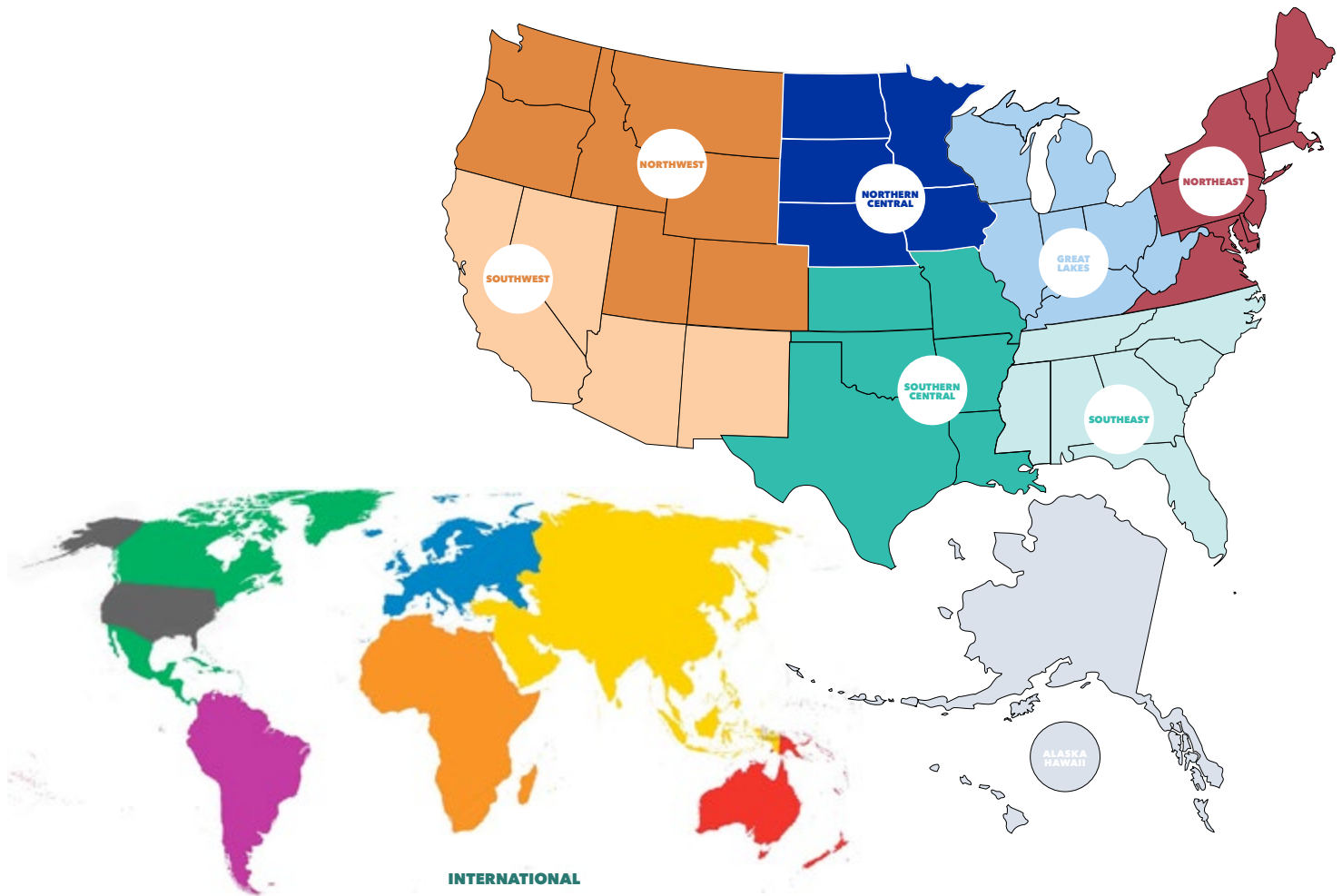

INTERNATIONAL

TERRITORY	800.444.1579	REPRESENTATIVE	EMAIL
Northwest	Ext. 2113	Fred Petzold	nwterritory@shor-line.com
Pacific	Ext. 2354	Tim Hemings	swterritory@shor-line.com
Southern Central	Ext. 2214	Doug Nietfeld	scentralterritory@shor-line.com
Northern Central	Ext. 2307	House	ncentralterritory@shor-line.com
Great Lakes	Ext. 2323	Jeremy Panzer	greatlakesterritory@shor-line.com
Southeastern	Ext. 2309	Mark Shea	seterritory@shor-line.com
Northeast	Ext. 2351	Guy Cosgrove	neterritory@shor-line.com
Alaska & Hawaii	Ext. 2314	Summer Woods	akhiterritory@shor-line.com
International	Ext. 2815	Adam Hermesch	international@shor-line.com

For orders in Canada, Mexico, Europe, Africa, Asia, Australia and South America, please contact [international@shor-line.com](mailto:international@shor-line.com) or call **1.913.281.1500**.





# CLASSIC

## V-TOP SURGERY TABLE



# LIGHTS

## PRELUDE SURGERY LIGHTS



# CONDOS

## CAT CONDOS AND SUITES



United States: 800-444-1579 [www.shor-line.com](http://www.shor-line.com)  
International: +913+281+1500 [www.shor-lineclearanceoutlet.com](http://www.shor-lineclearanceoutlet.com)  
Shor-Line/Schroer Manufacturing 511 Osage Avenue Kansas City, KS 66105

Shor-Line is not responsible for any typographical errors. SL 2017.

**PRODUCT CATALOG**®

**SHOR-LINE**